



Making Your World
A Little Easier.™

Use And Care

G U I D E

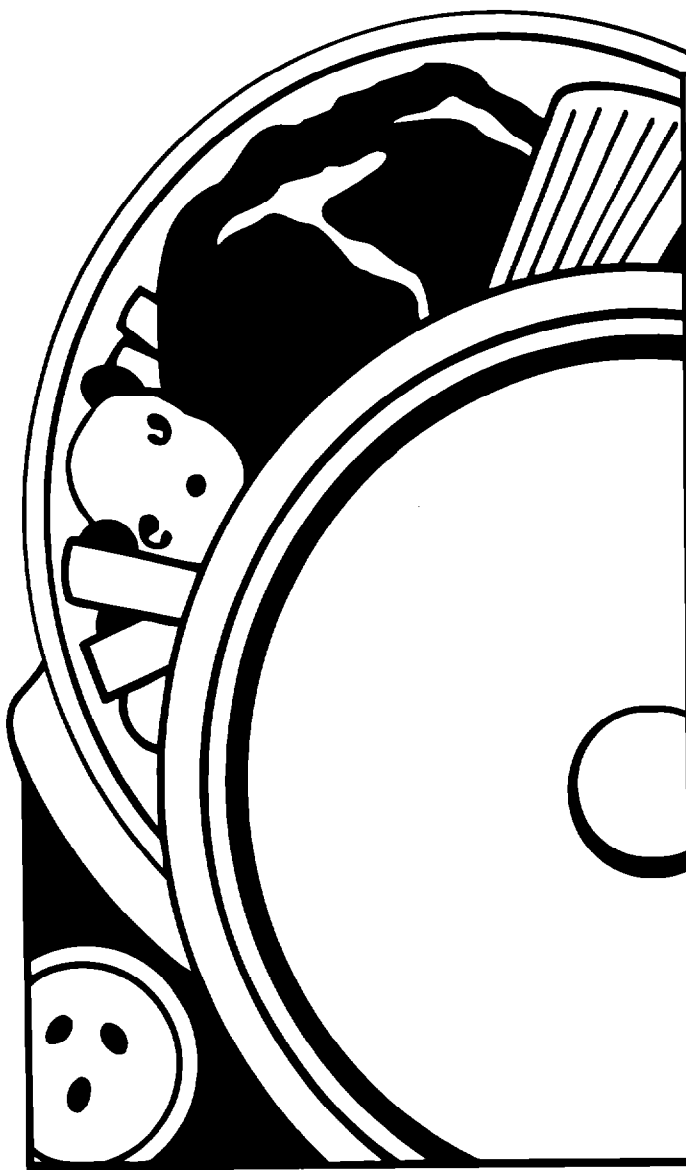

Table of Contents (complete).....	2
A Note to You	3
Microwave Oven	
Safety	4-7
Getting to Know Your Microwave Oven	8
Microwave Cooking	26
Convection Cooking	48
Combination Cooking	59
Caring for Your Microwave Oven	67
Cooking Guide	72
Questions and Answers	77
If You Need Assistance or Service	78
Warranty	84

1-800-253-1301

Call us with questions or comments.

MICROWAVE HOOD COMBINATION

7-98

PART NO. 3828W5A0266/

4359575

MODELS GH9115XE MH9115XE

Table of Contents

A Note to You	3	Using PIZZA REHEAT	44
Microwave Oven Safety	4-7	Using REHEAT	45
Important safety instructions	4	Using POPCORN	46
Precautions to avoid possible exposure to excessive microwave energy	6	Using ADD MINUTE	47
Electrical requirements	7	Adding or subtracting cook time	47
Grounding instructions	7	Convection Cooking	48
Getting to Know your Microwave Oven	8	How convection cooking works	48
How your microwave oven works	8	Convection baking without preheating	49
For the best cooking results	10	Convection baking with preheating	50
Radio interference	10	Convection broiling	52
Testing your microwave oven	10	Convenience foods cooking chart	54
Testing your dinnerware or cookware	11	Convection cooking with the temperature probe	55
Operating safety precautions	11	Temperature probe convection cooking chart	57
Electrical connection	13	Combination Cooking	59
Microwave oven features	14	How combination cooking works	59
Control panel features	15	Combination baking/roasting without preheating	60
Using the exhaust fan	18	Combination baking/roasting with preheating	61
Using the cooktop/countertop light	20	Combination cooking with the temperature probe	63
Using the bi-level metal rack	22	Temperature probe combination cooking chart	65
Setting the clock	23	Caring for Your Microwave Oven	67
Using the Minute Timer	24	Cleaning the microwave oven	67
Microwave Cooking	26	Caring for the filters	68
Cooking at high cook power	26	Replacing the cooktop and oven lights	70
Cooking at different cook powers	27	Cooking Guide	72
Cooking with more than one cook cycle	29	Reheating chart	72
Using AUTO DEFROST	30	Microwave cooking chart	73
Auto defrost chart	32	Microwave cooking tips	74
Defrosting tips	34	Oven cookware guide	76
Using WARM HOLD	35	Questions and Answers	77
Cooking with the temperature probe ...	36	If You Need Assistance or Service	78
Using AUTO ROAST	39	Warranty	84
Auto roast chart	40		
Using AUTO START	41		
Using SENSOR COOK	43		

A Note to You

Thank you for buying a WHIRLPOOL® appliance.

Because your life is getting busier and more complicated, WHIRLPOOL appliances are easy to use, save time, and help you manage your home better. To ensure that you enjoy years of trouble-free operation, we developed this Use and Care Guide. It is full of valuable information about how to operate and maintain your appliance properly and safely. Please read it carefully.

Also, please complete and mail in the **Product Registration Card** provided with your appliance. The card helps us notify you about any new information on your appliance.

Please record your model's information.

Whenever you call to request service for your appliance, you need to know your complete model number and serial number. You can find this information on the model and serial number plate (see diagram in the "Microwave oven features" section).

Please also record the purchase date of your appliance and your dealer's name, address, and telephone number.

Model Number _____

Serial Number _____

Purchase Date _____

Dealer Name _____

Dealer Address _____

Dealer Phone _____

Keep this book and the sales slip together in a safe place for future reference.

**Our Consumer Assistance Center
number is toll-free.**

1-800-253-1301

Microwave Oven Safety

Your safety and the safety of others is very important.

We have provided many important safety messages in this manual and on your appliance. Always read and obey all safety messages.



This is the safety alert symbol.

This symbol alerts you to hazards that can kill or hurt you and others.

All safety messages will be preceded by the safety alert symbol and the word "DANGER" or "WARNING." These words mean:

⚠ DANGER

You **will** be killed or seriously injured if you don't follow instructions.

⚠ WARNING

You **can** be killed or seriously injured if you don't follow instructions.

All safety messages will identify the hazard, tell you how to reduce the chance of injury, and tell you what can happen if the instructions are not followed.

IMPORTANT SAFETY INSTRUCTIONS

When using electrical appliances basic safety precautions should be followed, including the following:

WARNING: To reduce the risk of burns, electric shock, fire, injury to persons, or exposure to excessive microwave energy:

- Read all instructions before using the microwave oven.
- Read and follow the specific "PRECAUTIONS TO AVOID POSSIBLE EXPOSURE TO EXCESSIVE MICROWAVE ENERGY" found in this section.
- The microwave oven must be grounded. Connect only to properly grounded outlet. See "GROUNDING INSTRUCTIONS" found at the end of this section.
- Install or locate the microwave oven only in accordance with the provided Installation Instructions.
- Some products such as whole eggs in the shell and sealed containers – for example, closed glass jars – may explode and should not be heated in the microwave oven.
- Use the microwave oven only for its intended use as described in this manual. Do not use corrosive chemicals or vapors in the microwave oven. This type of oven is specifically designed to heat, cook, or dry food. It is not designed for industrial or laboratory use.
- As with any appliance, close supervision is necessary when used by children.
- Do not operate the microwave oven if it has a damaged cord or plug, if it is not working properly, or if it has been damaged or dropped.
- The microwave oven should be serviced only by qualified service personnel. Call an authorized Whirlpool service company for examination, repair, or adjustment.
- Do not cover or block any openings on the microwave oven.

MICROWAVE OVEN SAFETY

- Do not store the microwave oven outdoors. Do not use the microwave oven near water – for example, near a kitchen sink, in a wet basement, or near a swimming pool, and the like.
- Do not immerse cord or plug in water.
- Keep cord away from heated surfaces.
- Do not let cord hang over edge of table or counter.
- See door surface cleaning instructions in the “Caring for Your Microwave Oven” section.
- Suitable for use above both gas and electric cooking equipment.
- Intended to be used above ranges with maximum width of 36 inches.
- To reduce the risk of fire in the oven cavity:
 - Do not overcook food. Carefully attend the microwave oven if paper, plastic, or other combustible materials are placed inside the oven to facilitate cooking.
 - Remove wire twist-ties from paper or plastic bags before placing bag in oven.
 - If materials inside the oven should ignite, keep oven door closed, turn oven off, and disconnect the power cord, or shut off power at the fuse or circuit breaker panel.
 - Do not use the cavity for storage purposes. Do not leave paper products, cooking utensils, or food in the cavity when not in use.
 - Do not mount over a sink.
 - Do not store anything directly on top of the microwave oven when the microwave oven is in operation.

For microwave ovens with a ventilating hood:

- Clean Ventilating Hoods Frequently – Grease should not be allowed to accumulate on hood or filter.
- When flaming foods under the hood, turn the fan off. The fan, if operating, may spread the flame.
- Use care when cleaning the vent-hood filter. Corrosive cleaning agents, such as lye-based oven cleaners, may damage the filter.

– SAVE THESE INSTRUCTIONS –

PRECAUTIONS TO AVOID POSSIBLE EXPOSURE TO EXCESSIVE MICROWAVE ENERGY...

- (a)** Do not attempt to operate this oven with the door open since open-door operation can result in harmful exposure to microwave energy. It is important not to defeat or tamper with the safety interlocks.
- (b)** Do not place any object between the oven front face and the door or allow soil or cleaner residue to accumulate on sealing surfaces.
- (c)** Do not operate the oven if it is damaged. It is particularly important that the oven door close properly and that there is no damage to the:
 - (1) Door (bent),
 - (2) Hinges and latches (broken or loosened),
 - (3) Door seals and sealing surfaces.
- (d)** The oven should not be adjusted or repaired by anyone except properly qualified service personnel.

Electrical requirements

Observe all governing codes and ordinances. A 120 Volt, 60 Hz, AC only, 15 amp fused electrical supply is required. (A time-delay fuse is recommended.) It is recommended that a separate circuit serving only this appliance be provided.

⚠ WARNING



Electrical Shock Hazard

Plug into a grounded 3 prong outlet.

Do not remove ground prong.

Do not use an adapter.

Do not use an extension cord.

Failure to follow these instructions can result in death, fire, or electrical shock.

GROUNDING INSTRUCTIONS

For all cord connected appliances:
The microwave oven must be grounded. In the event of an electrical short circuit, grounding reduces the risk of electric shock by providing an escape wire for the electric current. The microwave oven is equipped with a cord having a grounding wire with a grounding plug. The plug must be plugged into an outlet that is properly installed and grounded.

WARNING: Improper use of the grounding can result in a risk of electric shock.

Consult a qualified electrician or serviceman if the grounding instructions are not completely understood, or if doubt exists as to whether the microwave oven is properly grounded.

Do not use an extension cord. If the power supply cord is too short, have a qualified electrician or serviceman install an outlet near the microwave oven.

For a permanently connected appliance:
This appliance must be connected to a grounded, metallic, permanent wiring system, or an equipment grounding conductor should be run with the circuit conductors and connected to the equipment grounding terminal or lead on the appliance.

Getting to Know Your Microwave Oven

This section discusses the concepts behind microwave cooking. It also shows you the basics you need to know to operate your microwave oven. Please read this information before you use your oven.

	!WARNING
	Explosion Hazard
	Do not store flammable materials such as gasoline near the microwave oven. Doing so can result in death, explosion, fire, or burns.

How your microwave oven works

Microwave ovens are safe. Microwave energy is not hot. It causes food to make its own heat, and it's this heat that cooks the food.

Microwaves are like TV waves or light waves. You cannot see them, but you can see what they do.

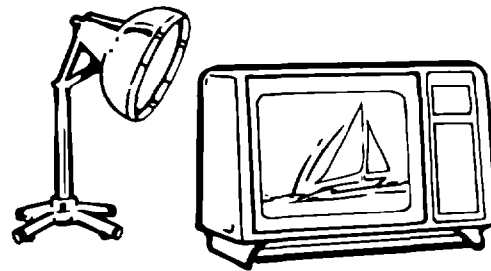

A magnetron in the microwave oven produces microwaves. The microwaves move into the oven where they contact food.

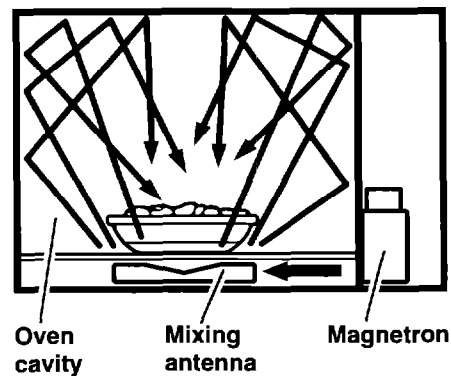

GETTING TO KNOW YOUR MICROWAVE OVEN

Microwaves pass through most glass, paper, and plastics without heating them so food absorbs the energy. Microwaves bounce off metal containers so food does not absorb the energy.

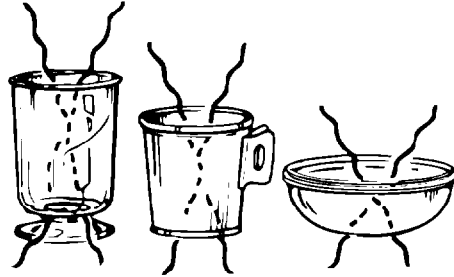

Microwaves may not reach the center of a roast. The heat spreads to the center from the outer, cooked areas just as in regular oven cooking. This is one of the reasons for letting some foods (for example, roasts or baked potatoes) stand for a while after cooking, or for stirring some foods during the cooking time.

The microwaves disturb water molecules in the food. As the molecules bounce around bumping into each other, heat is made, like rubbing your hands together. This is the heat that does the cooking.

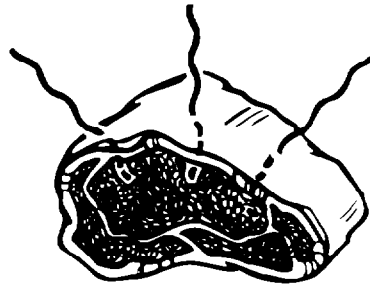

NOTE: Do not deep fry in the oven. Microwavable cookware is not suitable and it is difficult to maintain appropriate deep frying temperatures.

For the best cooking results

- **Always cook food** for the shortest cooking time recommended. Check to see how the food is cooking. If needed, touch the add minute pad while the oven is operating or after the cooking cycle is over (see the “Using add minute” section).
- **Stir, turn over, or rearrange** the food being cooked about halfway through the cooking time for all recipes. This will help make sure the food is evenly cooked.
- **If you do not have a cover** for a dish, use wax paper, or microwave-approved paper towels or plastic wrap. Remember to turn back a corner of the plastic wrap to vent steam during cooking.

Radio interference

Using your microwave oven may cause interference to your radio, TV, or similar equipment. When there is interference, you can reduce it or remove it by:

- **Cleaning** the door and sealing surfaces of the oven.
- **Adjusting** the receiving antenna of the radio or television.
- **Moving** the receiver away from the microwave oven.
- **Plugging** the microwave oven into a different outlet so that the microwave oven and receiver are on different branch circuits.

Testing your microwave oven

To test the oven put about 1 cup of cold water in a glass container in the oven. Close the door. Make sure it latches. Follow the directions in the “Cooking at high cook power” section to set the oven to cook for 2 minutes. When the time is up, the water should be heated.



Testing your dinnerware or cookware

Test dinnerware or cookware before using.

To test a dish for safe use, put it into the oven with a cup of water beside it. Cook at 100% cook power for one minute. **If the dish gets hot and water stays cool, do not use it.**

Some dishes (melamine, some ceramic dinnerware, etc.) absorb microwave energy, becoming too hot to handle and slowing cooking times. Cooking in metal containers not designed for microwave use could damage the oven, as could containers with hidden metal (twist-ties, foil lining, staples, metallic glaze or trim).

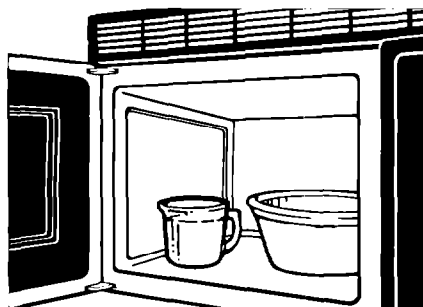

Operating safety precautions

Never cook or reheat a whole egg inside the shell. Steam buildup in whole eggs may cause them to burst and burn you, and possibly damage the oven. **Slice** hard-boiled eggs before heating. In rare cases, poached eggs have been known to explode. **Cover** poached eggs and **allow** a standing time of one minute before cutting into them.

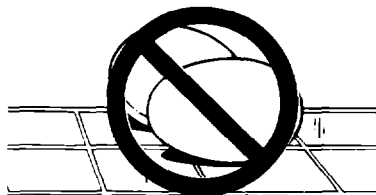

For best results, stir any liquid several times before heating or reheating. Liquids heated in certain containers (especially containers shaped like cylinders) may become overheated. The liquid may splash out with a loud noise during or after heating or when adding ingredients (coffee granules, tea bags, etc.). This can harm the oven and possibly injure someone.



Stir before heating

Never pull on the door or allow a child to swing on it when the door is open. Injury could result.

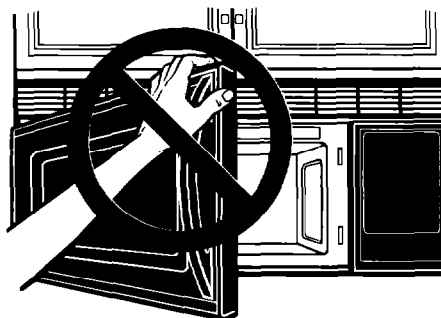

continued on next page

GETTING TO KNOW YOUR MICROWAVE OVEN

Use hot pads. Microwave energy does not heat containers, but heat from the food can make the container hot.

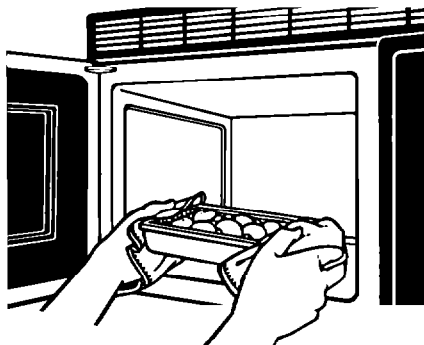

Do not overcook potatoes. Fire could result. At the end of the recommended cooking time, potatoes should be slightly firm because they will continue cooking during standing time.

After microwaving, wrap potatoes in foil and **set aside** for 5 minutes. They will finish cooking while standing.

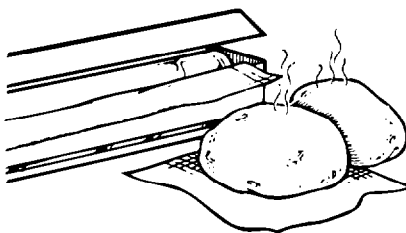

Do not start a microwave oven when it is empty. Product life may be shortened.

If you practice programming the oven, **put** a container of water in the oven.

It is normal for the oven door to look wavy after the oven has been running for a while.

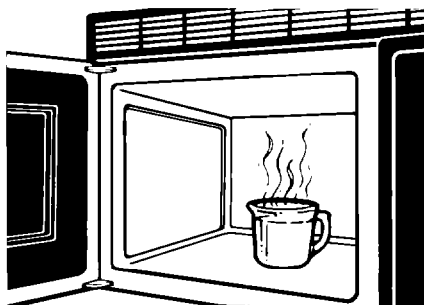

Do not use newspaper or other printed paper in the oven. Fire could result.

Do not dry flowers, fruit, herbs, wood, paper, gourds, or clothes in the oven. Fire could result.

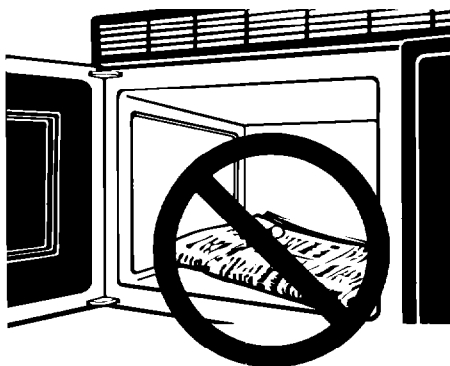

GETTING TO KNOW YOUR MICROWAVE OVEN

Do not try to melt paraffin wax in the oven. Paraffin wax will not melt in a microwave oven because it allows microwaves to pass through it.

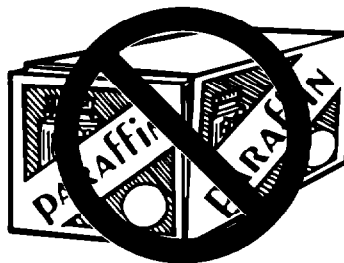

Electrical connection

If your electric power line or outlet voltage is less than 110 volts, cooking times may be longer. Have a qualified electrician check your electrical system.

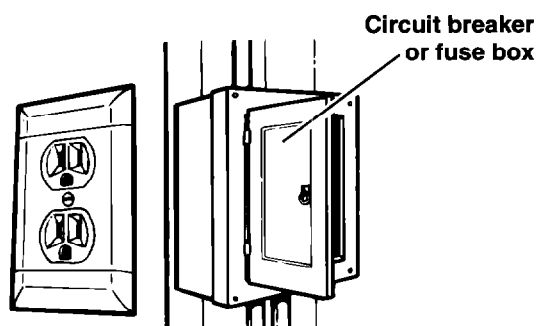

Microwave oven features

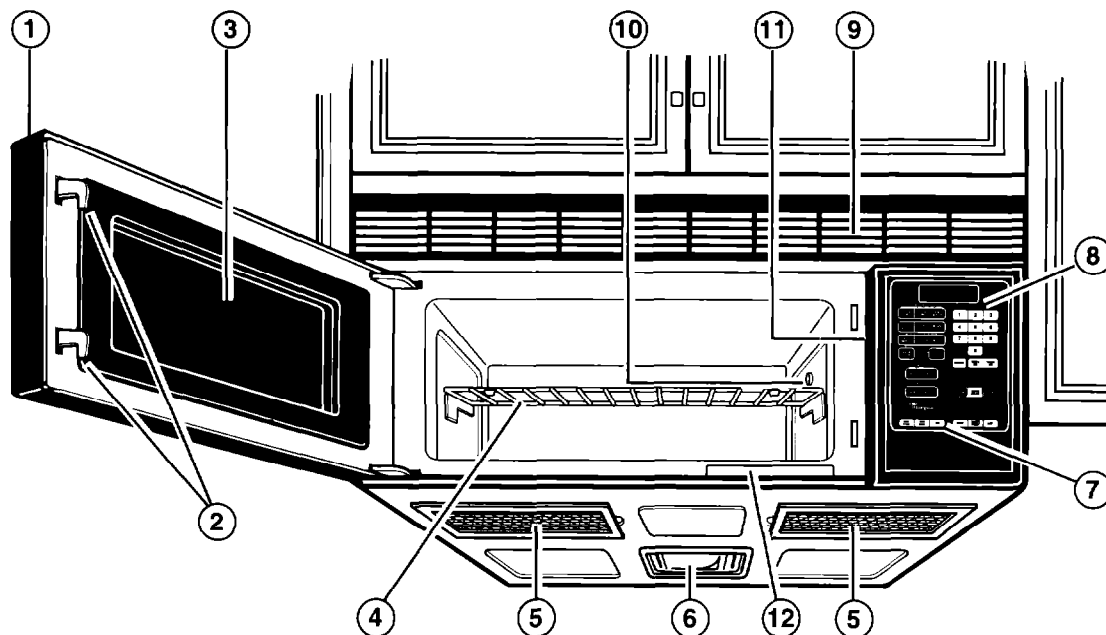

Your microwave oven is designed to make your cooking experience as enjoyable and productive as possible. To get you up and running quickly, the following is a list of the oven's basic features:

- 1. Door Handle.** Pull to open door.
- 2. Door Safety Lock System.** The oven will not operate unless the door is securely closed.
- 3. Window with Metal Shield.** The shield prevents microwaves from escaping. It is designed as a screen to allow you to view food as it cooks.
- 4. Two-Position Bi-Level Metal Rack.** Use for extra space when cooking in more than one container at the same time. See page 22 for more information.
- 5. Filter.** See page 68 for cleaning information.
- 6. Cooktop/Countertop Light.** Turn on to light your cooktop or countertop or use as a night light. See page 20 for more information.
- 7. Exhaust Fan and Cooktop Light Switches.** See pages 18-21 for more information.
- 8. Control Panel.** Touch the pads on this panel to perform all functions. See pages 15-17 for more information.
- 9. Vent Grille.**
- 10. Temperature Probe Socket** (on oven wall). Plug the Temperature Probe into this socket when using probe for cooking. See page 36 for more information.
NOTE: Do not store the Temperature Probe in the oven when probe is not being used. Store in a handy place.
- 11. Model and Serial Number Plate.**
- 12. Cooking Guide.** Use as a quick reference for the Auto Defrost, Auto Roast, and Sensor Cook settings.

Control panel features

Your microwave oven control panel lets you select the desired cooking function quickly and easily. All you have to do is touch the necessary Command Pad. The following is a list of all the Command and Number Pads located on the control panel. For more information, see pages 18-66.

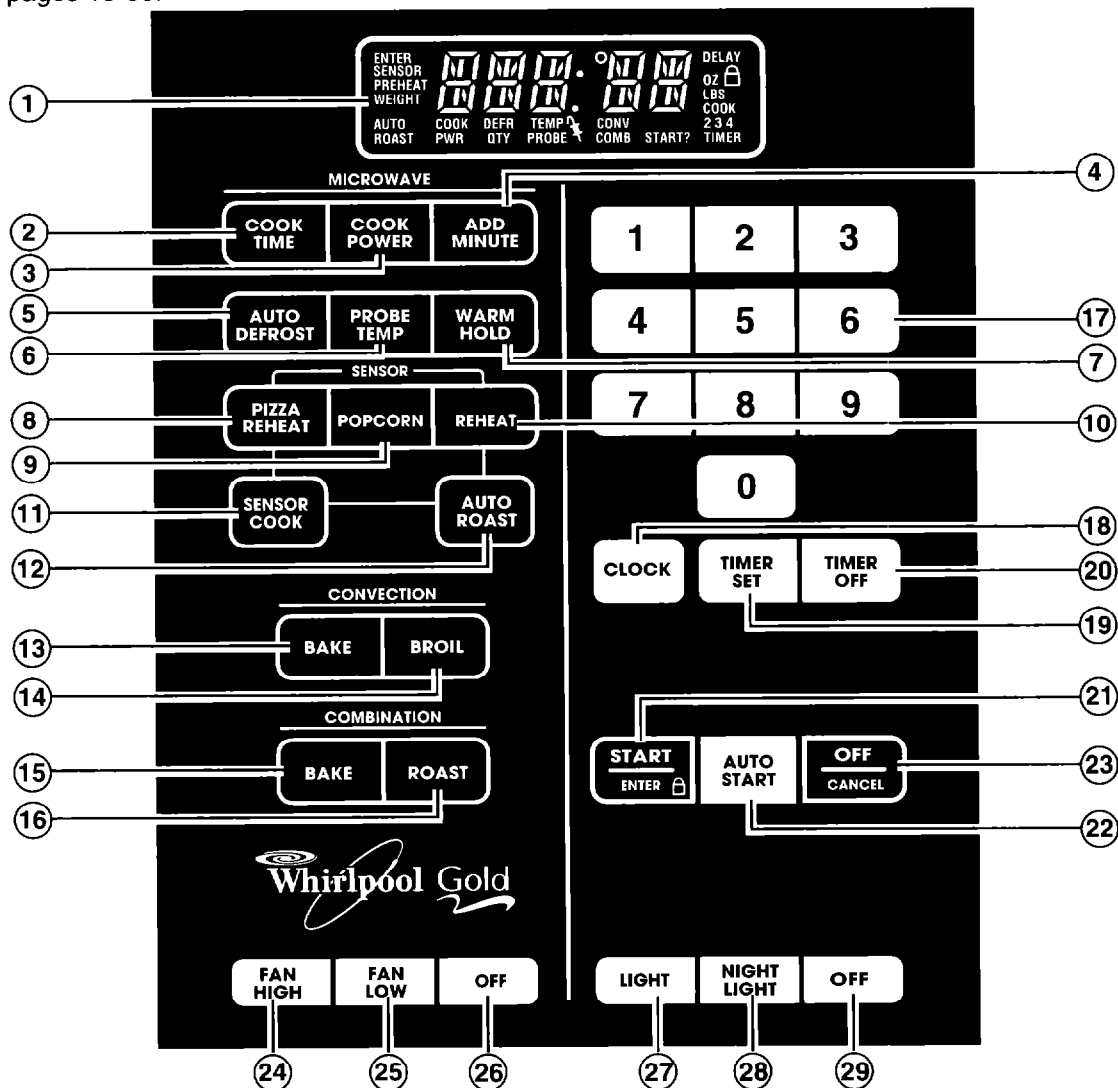

- 1. Display.** The Display includes a clock and indicators to tell you time of day, cooking time settings, and cooking functions selected.
- 2. COOK TIME.** Touch this pad followed by Number Pads to set a cooking time. See pages 26, 28, and 29 for more information.

- 3. COOK POWER.** Touch this pad after the cook time has been set, followed by a Number Pad to set the amount of microwave energy released to cook the food. The higher the number, the higher the microwave power or "cooking speed." See page 27 for more information. See the "Microwave cooking chart" on page 73 for specific Cook Powers to use for the foods you are cooking.

continued on next page 15

GETTING TO KNOW YOUR MICROWAVE OVEN

4. **ADD MINUTE.** Touch this pad to cook for 1 minute, at 100% Cook Power, or to add an extra minute, at the set Cook Power, to your cooking cycle. See page 47 for more information.
5. **AUTO DEFROST.** Touch this pad followed by Number Pads to thaw frozen meat by weight. See page 30 for more information.
6. **PROBE TEMP.** Touch this pad when using the Temperature Probe to cook. Touch PROBE TEMP followed by Number Pads to set desired final food temperature. See page 36 for more information.
7. **WARM HOLD.** Touch this pad to keep hot, cooked foods safely warm in your microwave oven for up to 99 minutes, 99 seconds. WARM HOLD can be used by itself, or it can automatically follow a cooking cycle. See page 35 for more information.
8. **PIZZA REHEAT.** Touch this pad to reheat pizza at a preset Cook Power. The oven's sensor will tell the oven how long to heat depending on the amount of humidity it detects from the pizza. See page 44 for more information.
9. **POPCORN.** Touch this pad to pop popcorn at a preset Cook Power. The oven's sensor will tell the oven how long to cook depending on the amount of humidity it detects from the popcorn. See page 46 for more information.
10. **REHEAT.** Touch this pad to reheat food at a preset Cook Power. The oven's sensor will tell the oven how long to heat depending on the amount of humidity it detects from the food. See page 45 for more information.
11. **SENSOR COOK.** Touch this pad to cook at a preset Cook Power. The oven's sensor will tell the oven how long to cook depending on the amount of humidity it detects from the food. See page 43 for more information.
12. **AUTO ROAST.** Touch this pad to roast with the Temperature Probe. See page 39 for more information.
13. **CONVECTION BAKE.** Touch this pad to bake with convection heat. See pages 49-52 and pages 55-56 for more information.
14. **CONVECTION BROIL.** Touch this pad to broil with convection heat. See pages 52-53 for more information.
15. **COMBINATION BAKE.** Touch this pad to bake with both convection heat and microwaves. See pages 60-64 for more information.
16. **COMBINATION ROAST.** Touch this pad to roast with both convection heat and microwaves. See pages 60-64 for more information.
17. **Number Pads.** Touch Number Pads to enter cooking times, Cook Powers, temperatures, weights, or food categories.
18. **CLOCK.** Touch this pad to enter the correct time of day. See page 23 for more information.
19. **TIMER SET.** Touch this pad to set the Minute Timer. See page 24 for more information.
20. **TIMER OFF.** Touch this pad to cancel the Minute Timer. See page 25 for more information.
21. **START/ENTER.** Touch this pad to start a function. If you open the door after the oven begins to cook, retouch START/ENTER. See page 17 for more information.
22. **AUTO START.** Touch this pad to program your oven to begin cooking automatically at a chosen time later in the day. See page 41 for more information.
23. **OFF/CANCEL.** Touch this pad to erase an incorrect command, cancel a program during cooking, or to clear the Display. See page 17 for more information.
24. **FAN HIGH.** Touch this pad to turn on the fan at high speed. See page 18 for more information.
25. **FAN LOW.** Touch this pad to turn on the fan at low speed. See page 18 for more information.

GETTING TO KNOW YOUR MICROWAVE OVEN

26. **OFF.** Touch this pad to turn off the fan. See page 18 for more information.
27. **LIGHT.** Touch this pad to turn on the cooktop/countertop light. See page 20 for more information.
28. **NIGHT LIGHT.** Touch this pad to turn on the cooktop/countertop night light. See page 20 for more information.
29. **OFF.** Touch this pad to turn off the cooktop/countertop light. See page 20 for more information.

NOTES:

- If you have entered all settings for a function but do not touch START/ENTER within 5 seconds, the Start? indicator light will appear.
- If you open the door while the oven is on and then shut the door, the Start? indicator light will appear. Touch START/ENTER to restart the oven.
- If you choose a function but do not press another Command Pad within 1 minute, the display returns to the time of day and you have to start over.

Audible signals

Audible signals are available to guide you when setting and using your oven:

- **A programming tone will sound** each time you touch a pad.
- **One long tone** signals the end of a Minute Timer countdown.
- **Four tones** signal the end of a cooking cycle.
- **Two tones** sound once every minute after an End-of-Cooking signal as a reminder if food has not been removed from oven.
- **Three tones** sound if you have made an incorrect entry.

To disable audible signals:

- **Touch and hold** Number Pad 1 for 4 seconds to disable programming tones.

To turn signals back on:

Touch and hold Number Pad 1 for 4 seconds.

NOTE: Three tones, followed by two tones, will sound when audible signals are turned on or off.

Interrupting cooking

You can stop the oven during a cycle by opening the door. The oven stops heating and the fan stops, but the light stays on.

To restart cooking, close the door and

TOUCH



If you do not want to continue cooking:

- **Close the door and the light goes off.**

OR

- **TOUCH**



Using the learning feature

You can see your microwave oven's functions without turning the oven on.

NOTE: This feature can only be used when the microwave oven is first connected to power. You cannot use the learning feature after a Command Pad has been touched.

To set the learning feature:

1. **Open** the door and **keep** it open.
2. **Touch and hold** Number Pad 0 for 4 seconds. Three tones, followed by two tones, will sound.
3. **Release** Number Pad 0.
4. **Shut** the door to start the learning feature.

To cancel the learning feature:

Touch OFF/CANCEL.

Using the safety lock

The safety lock prevents unwanted use of the microwave oven by disabling the control panel Command Pads.

To lock or deactivate the control panel:

Touch and hold START/ENTER for 4 seconds. Three tones, followed by 2 tones, will sound and  will appear on the Display.

To cancel the safety lock:

Touch and hold START/ENTER for 4 seconds. Two tones will sound and  will be cleared from the Display.

Using the exhaust fan

The three pads on the bottom left of the control panel control the two-speed Exhaust Fan.



1. Choose fan speed.

NOTE: If the temperature gets too hot around the microwave oven, the exhaust fan in the vent hood will automatically turn on at the LOW setting to protect the oven. It may stay on up to an hour to cool the oven. When this occurs, the OFF pad will not turn the fan off.

TOUCH



OR



2. Turn off fan when desired.

TOUCH



To set fan to run for a specific time:

1. Start fan.

TOUCH



OR



2. Choose timer.

NOTE: If both the fan and light are operating and the TIMER SET pad is touched twice, both the fan and light will be controlled by the timer.

TOUCH



(twice within
3 seconds)

YOU SEE



GETTING TO KNOW YOUR MICROWAVE OVEN

3. Set stop time.

Example to stop the fan at 1 hour 30 minutes, when time of day is 12 o'clock:

NOTE: You can set the stop time up to the next 11 hours and 59 minutes.

TOUCH

1

3

0

YOU SEE

ENTER 1:30 TIME

4. Start timer.

NOTE: The letter "F" indicates the timed fan feature has been selected. If both the timed fan and light feature have been selected, an "H" (Hood) will be displayed.

At end of time, the current time of day will show and no tones will sound.

TOUCH

START
ENTER

OR

TIMER
SET

YOU SEE

F 1:30

To check the stop time:

The set time will be displayed for 3 seconds.

TOUCH

TIMER
SET

To cancel timer:

NOTE: Canceling the timer will cause the fan to shut off; however, canceling the fan will not cancel the timer.

TOUCH

TIMER
OFF

GETTING TO KNOW YOUR MICROWAVE OVEN

Using the cooktop/countertop light

The three pads on the bottom right of the control panel control the cooktop/countertop light.



1. Turn on light.

TOUCH



OR



2. Turn off light when desired.

TOUCH



To set light to be on for a specific time:

1. Turn on light.

TOUCH



OR



2. Choose timer.

NOTE: If both the fan and light are operating and the TIMER SET pad is touched twice, both the fan and light will be controlled by the timer.

TOUCH



(twice within 3 seconds)

YOU SEE



GETTING TO KNOW YOUR MICROWAVE OVEN

3. Set stop time.

Example to turn off the light at 1 hour 30 minutes, when time of day is 12 o'clock:

NOTE: You can set the time up to the next 11 hours and 59 minutes.

TOUCH

1

3

0

YOU SEE



4. Start timer.

NOTE: The letter "L" indicates the timed light feature has been selected. If both the timed light and fan feature have been selected, an "H" (Hood) will be displayed.

At end of time, the current time of day will show and no tones will sound.

TOUCH

START
ENTER

OR

TIMER
SET

YOU SEE



To check the stop time:

The set time will be displayed for 3 seconds.

TOUCH

TIMER
SET

To cancel timer:

NOTE: Canceling the timer will cause the light to shut off; however, canceling the light will not cancel the timer.

TOUCH

TIMER
OFF

Using the bi-level metal rack

The Bi-Level Metal Rack (Part No. 4358537) gives you extra space when cooking in more than one container at the same time. The metal rack must not be turned upside-down on the bottom of the oven. You can also use the Bi-Level Metal Rack for convection cooking.

If you need a replacement rack and your Whirlpool dealer does not stock the rack, you can order it, by part number, by calling **1-800-253-1301**. Follow the instructions and telephone prompts you hear.

Inserting the rack

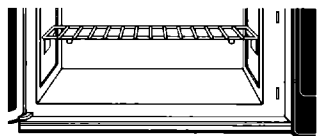

Normal position: Insert the rack securely on the rack guides on the side walls of the oven.

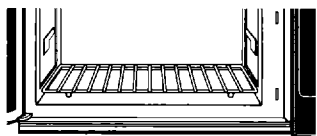

Bottom position: Insert rack securely on bottom of oven when using taller containers.

⚠ WARNING



Burn Hazard

Use oven mitts to remove items from microwave.

Do not touch areas near oven vent openings during use.

Failure to follow these instructions can result in burns.

NOTES:

- **Do not store** the metal rack in the oven. Arcing and damage to the oven could result if someone accidentally starts the oven.
- **Use rack** only in the microwave oven.
- **Do not use rack** with browning dish.
- **Do not let food** container on rack touch the top or sides of the oven.
- **Do not cook foods** directly on rack without putting them in containers first.
- **Do not place** a metal cooking container on rack when microwave cooking or combination cooking. Place a microwave-safe plate under container.

Setting the clock

When your microwave oven is first plugged in or after a power failure, the Display will show "888:88". For the first 30 seconds after the power is on, you can set the clock time without touching CLOCK. After 30 seconds have gone by, you must follow the directions below to set the time. If a time of day is not set, "888:88" will show on the Display until you touch CLOCK.

NOTES:

- **You can** only set the clock if the oven is not cooking food.
- **If you touch in** an incorrect time and touch CLOCK, three tones will sound. Enter the correct time.
- **If you touch OFF/CANCEL** while setting the clock, the Display will show the last time of day set or ":" if no time of day has been set.

To set time:

1. Choose setting.

TOUCH



YOU SEE



(for 3 seconds)

2. Enter time of day.

Example for 12:00:

TOUCH



YOU SEE



3. Complete entry.

TOUCH



OR



YOU SEE



Using the Minute Timer

You can use your microwave oven as a minute timer. Use the Minute Timer for timing up to 99 minutes, 99 seconds.

NOTE: The oven can operate while the Minute Timer is in use. To see the Minute Timer while the oven is cooking, touch **TIMER SET**. The Display will return to the cooking time countdown after 3 seconds.

1. Touch **TIMER SET**.

TOUCH



YOU SEE



2. Enter time to be counted down.

Example for 1 minute, 30 seconds:

NOTE: If you enter more than four digits, 3 tones will sound. Touch **START/ENTER** to count down the 3-digit time you have entered or touch **TIMER OFF** to clear the Display. To start over, touch **TIMER SET** and re-enter desired time.

TOUCH



YOU SEE



3. Start countdown.

NOTE: If you do not do this step within 3 seconds of doing Step 2, "START?" will be displayed. You then have 1 minute to touch **START/ENTER** or **TIMER SET** before the Display returns to time of day.

TOUCH



OR



YOU SEE

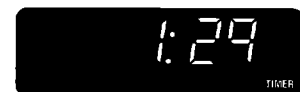

GETTING TO KNOW YOUR MICROWAVE OVEN

At end of countdown:

YOU SEE



(one tone will sound)

To cancel Minute Timer:

During countdown:

TOUCH



YOU SEE



(time of day)

After countdown:



Microwave Cooking

This section gives you instructions for operating each function. Please read these instructions carefully.

Cooking at high cook power

1. Put food in oven and close the door.

2. Set cooking time.

TOUCH



YOU SEE



Example for 1 minute, 30 seconds:

TOUCH

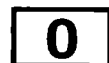
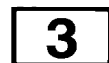

YOU SEE



3. Start oven.

TOUCH



YOU SEE



At end of cooking time:

YOU SEE



Changing instructions

You can change the cooking time after cooking starts by repeating Steps 2 and 3.

Cooking at different cook powers

For best results, some recipes call for different Cook Powers. The lower the Cook Power, the slower the cooking. Each Number Pad also stands for a different percentage of Cook Power. Many microwave cookbook recipes tell you by number, percent, or name which Cook Power to use.

The following chart gives the percentage of Cook Power each Number Pad stands for, and the Cook Power name usually used. It also tells you when to use each Cook Power. Follow recipe or food package instructions if available.

COOK POWER	NAME	WHEN TO USE IT
10=100% of full power	High	<ul style="list-style-type: none"> • Quick heating many convenience foods and foods with high water content, such as soups and beverages • Cooking small tender pieces of meat, ground meat, poultry pieces, fish fillets, and vegetables
9=90% of full power		<ul style="list-style-type: none"> • Heating cream soups
8=80% of full power		<ul style="list-style-type: none"> • Heating rice, pasta, or casseroles
7=70% of full power	Medium-High	<ul style="list-style-type: none"> • Cooking and heating foods that need a Cook Power lower than high (for example, whole fish and meat loaf) or when food is cooking too fast • Reheating a single serving of food
6=60% of full power		<ul style="list-style-type: none"> • Cooking requiring special care, such as cheese and egg dishes, pudding, and custards • Finishing cooking casseroles
5=50% of full power	Medium	<ul style="list-style-type: none"> • Cooking ham, whole poultry, and pot roasts • Melting chocolate
4=40% of full power		<ul style="list-style-type: none"> • Simmering stews • Heating pastries
3=30% of full power	Medium-Low, Defrost	<ul style="list-style-type: none"> • Defrosting foods, such as bread, fish, meats, poultry, and precooked foods
2=20% of full power		<ul style="list-style-type: none"> • Softening butter, cheese, and ice cream
1=10% of full power	Low	<ul style="list-style-type: none"> • Keeping food warm • Taking chill out of fruit

NOTE: Once cook time has been entered you can also use the Cook Power pad as a second Minute Timer by entering "0" for the Cook Power. The oven will count down the cooking time you set without cooking.

MICROWAVE COOKING

1. Put food in oven and close the door.

2. Set cooking time.

TOUCH



YOU SEE



Example for 7 minutes, 30 seconds:

TOUCH



YOU SEE



3. Set Cook Power.

TOUCH



YOU SEE

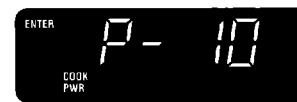

Example for 50% Cook Power:

TOUCH



YOU SEE



4. Start oven.

TOUCH



YOU SEE

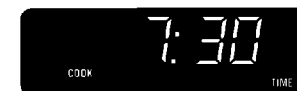

At end of cooking time:

YOU SEE



Changing instructions

You can change the cooking time or Cook Power after cooking starts by repeating Steps 2 and/or 3 and 4.

Cooking with more than one cook cycle

For best results, some recipes call for one Cook Power for a certain length of time, and another Cook Power for another length of time. Your oven can be set to change from one to another automatically, for up to two cycles.

1. Put food in oven and close the door.

2. Set cooking time for first cycle.

TOUCH



YOU SEE



Example for 7 minutes, 30 seconds:

TOUCH



YOU SEE



3. Set Cook Power for first cycle.

TOUCH



YOU SEE



Example for 50% Cook Power:

TOUCH



YOU SEE



4. Repeat Steps 2 and 3 to set cooking time and Cook Power for the second cycle.

continued on next page

MICROWAVE COOKING

5. Start oven.

After the first cycle is over, the next cycle will count down.

At end of cooking time:

TOUCH



YOU SEE

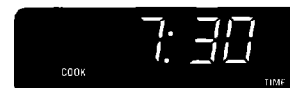

(first cycle)

YOU SEE



Changing instructions

You can change times or Cook Powers for a cycle any time after that cycle starts by repeating Steps 2 and/or 3 and 4.

Using AUTO DEFROST

Your microwave oven automatically defrosts a variety of common meats at preset Cook Powers for preset times. The two-stage defrost cycle is programmed for Meat, Poultry, and Fish. All you do is touch the Command Pad assigned to the desired category and enter the weight of the items being defrosted. Your microwave oven does the rest.

NOTES:

- See the "Auto defrost chart" for defrosting directions for each food.
- To defrost items not listed in "Auto defrost chart" use 30% Cook Power. Refer to a reliable cookbook for defrosting information.

Refer to the following chart to choose a category:

CATEGORY	TOUCH AUTO DEFROST
Meat	once
Poultry	twice
Fish	three times

1. Put frozen food in oven and close the door.

2. Touch **AUTO DEFROST** to choose food category (once for Meat, twice for Poultry, three times for Fish).

Example for Meat:

TOUCH



(once)

YOU SEE



MICROWAVE COOKING

After 3 seconds:

YOU SEE



3. Enter food's weight (in pounds and tenths of a pound).

Example for 1.2 lbs:

NOTES:

- For converting fractions of a pound to decimals, see "Weight conversion chart."
- If you enter an incorrect weight, repeat Steps 2 and 3.

TOUCH



YOU SEE

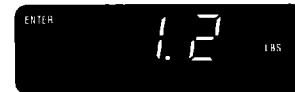

4. Start oven.

TOUCH



YOU SEE



5. After half the defrost time is over, Display will prompt you to turn over food.

Open door, turn over food, and shield any warm portions.

NOTE: If you do not open the door within 2 minutes, the Display will resume the countdown.

YOU SEE



6. Restart oven.

TOUCH



YOU SEE



(time remaining – time may vary)

At end of defrosting time:

YOU SEE



Auto defrost chart

Meat setting

FOOD	AT PAUSE	SPECIAL INSTRUCTIONS
Beef		Meat of irregular shape and large, fatty cuts of meat should have the narrow or fatty areas shielded with foil at the beginning of a defrost cycle.
Ground Beef, Bulk	Remove thawed portions with fork. Turn over. Return remainder to oven.	Do not defrost less than 1/4 lb. Freeze in doughnut shape.
Ground Beef, Patties	Separate and rearrange.	Do not defrost less than two 4 oz patties. Depress center when freezing.
Round Steak	Turn over. Cover warm areas with aluminum foil.	Place on a microwavable roasting rack.
Tenderloin Steak	Turn over. Cover warm areas with aluminum foil.	Place on a microwavable roasting rack.
Stew Beef	Remove thawed portions with fork. Separate remainder. Return remainder to oven.	Place in a microwavable baking dish.
Pot Roast, Chuck Roast	Turn over. Cover warm areas with aluminum foil.	Place on a microwavable roasting rack.
Rib Roast	Turn over. Cover warm areas with aluminum foil.	Place on a microwavable roasting rack.
Rolled Rump Roast	Turn over. Cover warm areas with aluminum foil.	Place on a microwavable roasting rack.
Lamb		
Cubes for Stew	Remove thawed portions with fork. Return remainder to oven.	Place in a microwavable baking dish.
Chops (1 inch thick)	Separate and rearrange.	Place on a microwavable roasting rack.
Pork		
Chops (1/2 inch thick)	Separate and rearrange.	Place on a microwavable roasting rack.
Hot Dogs	Separate and rearrange.	Place on a microwavable roasting rack.
Spareribs, Country-Style Ribs	Turn over. Cover warm areas with aluminum foil.	Place on a microwavable roasting rack.
Sausage, Links	Separate and rearrange.	Place on a microwavable roasting rack.
Sausage, Bulk	Remove thawed portions with fork. Turn over. Return remainder to oven.	Place in a microwavable baking dish.
Loin Roast, Boneless	Turn over. Cover warm areas with aluminum foil.	Place on a microwavable roasting rack.

MICROWAVE COOKING

Fish setting

FOOD	AT PAUSE	SPECIAL INSTRUCTIONS
Fish		
Fillets	Turn over. Separate fillets when partially thawed.	Place in a microwavable baking dish. Carefully separate fillets under cold water.
Steaks	Separate and rearrange.	Place in a microwavable baking dish. Run cold water over to finish defrosting.
Whole	Turn over.	Place in a microwavable baking dish. Cover head and tail with foil; do not let foil touch sides of microwave oven. Finish defrosting by immersing in cold water.
Shellfish		
Crabmeat	Break apart. Turn over.	Place in a microwavable baking dish.
Lobster Tails	Turn over and rearrange.	Place in a microwavable baking dish.
Shrimp	Separate and rearrange.	Place in a microwavable baking dish.
Scallops	Separate and rearrange.	Place in a microwavable baking dish.

Poultry setting

FOOD	AT PAUSE	SPECIAL INSTRUCTIONS
Chicken		
Whole (up to 9½ lbs)	Turn over (finish defrosting breast-side down). Cover warm areas with aluminum foil.	Place chicken breast-side up on a microwavable roasting rack. Finish defrosting by immersing in cold water. Remove giblets when chicken is partially defrosted.
Cut Up	Separate pieces and rearrange. Turn over. Cover warm areas with aluminum foil.	Place on a microwavable roasting rack. Finish defrosting by immersing in cold water.
Cornish Hens		
Whole	Turn over. Cover warm areas with aluminum foil.	Place on a microwavable roasting rack. Finish defrosting by immersing in cold water.
Turkey		
Breast (under 6 lbs)	Turn over. Cover warm areas with aluminum foil.	Place on a microwavable roasting rack. Finish defrosting by immersing in cold water.

MICROWAVE COOKING

Weight conversion chart

You are probably used to food weights as being in pounds and ounces that are fractions of a pound (for example 4 ounces equals $\frac{1}{4}$ pound). However, in order to enter food weight in AUTO DEFROST, you must specify pounds and tenths of a pound.

If the weight on the food package is in fractions of a pound, you can use the following chart to convert the weight to decimals.

NUMBER AFTER DECIMAL	EQUIVALENT OUNCE WEIGHT
.10	1.6
.20	3.2
.25 One-Quarter Pound	4.0
.30	4.8
.40	6.4
.50 One-Half Pound	8.0
.60	9.6
.70	11.2
.75 Three-Quarters Pound	12.0
.80	12.8
.90	14.4
1.00 One Pound	16.0

Defrosting tips

- **When using** AUTO DEFROST, the weight to be entered is the net weight in pounds and tenths of pounds (the weight of the food minus the container).
- **Only use** AUTO DEFROST for raw food. AUTO DEFROST gives best results when food to be thawed is a minimum of 0°F. If food has been stored in a refrigerator-freezer that does not maintain a temperature of 0°F or below, always program a lower food weight (for a shorter defrosting time) to prevent cooking the food.
- **If the food is kept outside** the freezer for up to 20 minutes, enter a lower food weight.
- **If the food is kept outside** the freezer for more than 20 minutes, and for defrosting ready-made food, defrost by time and power and let stand after defrosting.
- **The shape of** the package affects how quickly food will defrost. Shallow packages will defrost more quickly than a deep block.
- **As food begins** to defrost, separate the pieces. Separated pieces defrost more evenly.
- **Use small pieces** of aluminum foil to shield parts of food such as chicken wings, leg tips, fish tails, or areas that start to get warm. Make sure the foil does not touch the sides, top, or bottom of the oven. The foil can damage the oven lining.
- **For better results, a preset standing time** is included in the defrosting time. This may make the defrosting time seem longer than expected. (For more information on standing time, see the "Microwave cooking tips" section.)

Using WARM HOLD

You can safely keep hot, cooked food warm in your microwave oven for up to 99 minutes, 99 seconds (about 1 hour, 40 minutes). You can use WARM HOLD by itself, or to automatically follow a cooking cycle.

NOTES:

- **WARM HOLD** operates for up to 99 minutes, 99 seconds.
- **Opening** the oven door cancels WARM HOLD. Close the door and touch WARM HOLD, then touch START/ENTER if additional WARM HOLD time is desired.
- **Food cooked covered** should be covered during WARM HOLD.
- **Pastry items** (pies, turnovers, etc.) should be uncovered during WARM HOLD.
- **Complete meals** kept warm on a dinner plate should be covered during WARM HOLD.
- **Do not use** more than one complete WARM HOLD cycle (about 1 hour, 40 minutes). The quality of some foods will suffer with extended time.

1. Put hot, cooked food in oven and close the door.

2. Choose setting.

TOUCH



YOU SEE



To make WARM HOLD automatically follow another cycle:

- **While you are touching in cooking instructions, touch WARM HOLD** before touching START/ENTER.
- **When the last cooking cycle is over,** you will hear two tones. "WARM" will come on while the oven continues to run.
- **You can set WARM HOLD to follow** AUTO DEFROST, COOK, temperature probe cooking, or multi-cycle cooking.

Cooking with the temperature probe

The Temperature Probe helps take the guesswork out of cooking roasts and larger casseroles. The probe is designed to turn off the oven when it senses the temperature you chose (between 90°F and 200°F). See your cookbook for helpful information on cooking different types of food.

NOTE: If you have not plugged in the Temperature Probe properly or if probe is defective, "PROBE" will appear on the Display, three tones will sound, and the oven will not turn on. After correcting the problem or removing the probe, touch START/ENTER to clear the Display.

1. Insert probe into food.

Insert at least $\frac{1}{3}$ of the Temperature Probe into the food. (See "Temperature probe cooking tips" in this section.)

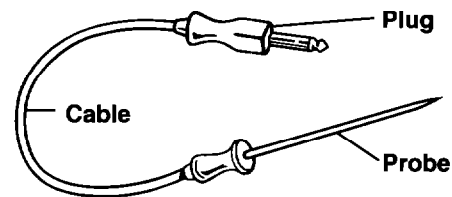

2. Place food in oven and plug probe into socket on oven wall.

Make sure the probe does not touch any part of the oven interior – including the rack.

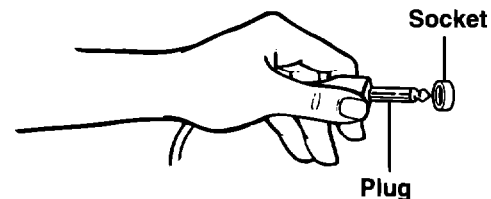

3. Close the door.

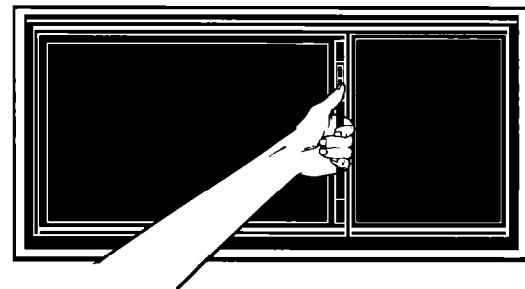

4. Choose setting.

NOTE: Food will automatically cook to 160°F if you do not specify a final food temperature. If you want to specify a final food temperature, do Step 5. Otherwise, skip to Step 6.

TOUCH

PROBE
TEMP

YOU SEE



5. Set desired final food temperature (optional).

Example for 180°F:

TOUCH

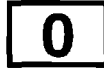

YOU SEE



6. Start oven.

TOUCH



YOU SEE



When food temperature reaches 90°F:

The displayed temperature will change each time food temperature increases by 5°F. If the temperature does not change after 20 minutes, the Display will show "CHECK" and "PROBE."

When food reaches the desired temperature:

YOU SEE



YOU SEE



To change final food temperature after oven has started:

1. **Touch** PROBE TEMP. You will see the current set temperature.
2. **Re-enter** desired temperature.
3. **Touch** START/ENTER.

NOTE: If you do not touch START/ENTER within 1 minute after entering the new temperature, the oven will resume heating to the first temperature you set. You can ensure that your new temperature is set by touching PROBE TEMP (to display the set temperature for 3 seconds).

MICROWAVE COOKING

Temperature probe cooking tips:

- **Stir** foods during cooking when recommended.
- **Stir** soups, casseroles, and drinks before serving.
- **Cover** roasts with foil after cooking and **let stand** a few minutes. **Remove** foil if you decide to cook it longer.
- **Remove** the probe from the oven when not cooking by temperature.

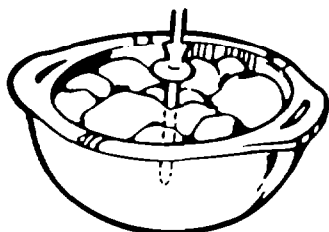

- **For casseroles**, the tip of the probe should be in the center of the food. **Stir** foods when recommended. **Replace** the probe.

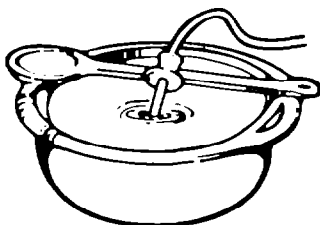

- **For liquids**, **balance** the probe on a wooden spoon or spatula so the tip of the probe is in the center of the liquid.

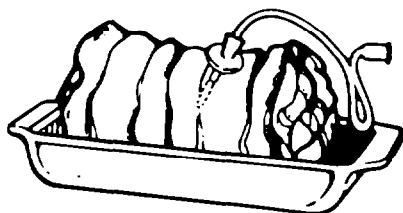

- **For roasts**, the tip of the probe should be in the center of the largest muscle, but not touching fat or bone.

- **Casseroles** cooked using the Temperature Probe should be made from precooked foods. **Do not use raw** meats, raw vegetables, and cream sauces in casseroles.
- **Dry casseroles** do not work well.
- **Thaw** frozen casseroles and meats in the microwave oven before inserting the probe.
- **If you are cooking** more than one individual serving at the same time, such as mugs of soup, **check** the probe setting in several of the items – all the mugs may not heat at the same rate.
- **Dry meat loaf** mixtures do not work well.
- **Check pork and poultry** with thermometer in 2-3 places to ensure adequate doneness.
- **Roasts may vary** in size, shape, and composition. **Use** the Temperature Probe as a guide.

Don't:

- **let probe or probe cable** touch any part of the oven interior.
- **let probe touch foil** (if used). You can keep foil away from probe with wooden toothpicks. **Remove** foil if arcing occurs.
- **use** paper, plastic wrap, or plastic containers. They will be in the oven too long and might distort.
- **force** probe into frozen food.
- **plug** the pointed end of the Temperature Probe into the socket.

Removing and cleaning the Temperature Probe:

1. After oven has shut off, **unplug** the Temperature Probe using an oven mitt or hot pad.
2. **Wipe** probe with a sudsy cloth and **dry** thoroughly. **Use** a plastic scouring pad to remove cooked-on foods.
3. **You can place** probe in the silverware basket of a dishwasher.

⚠ WARNING



Burn Hazard

Use an oven mitt to remove temperature probe.

Failure to do so can result in burns.

Using AUTO ROAST

AUTO ROAST lets you roast food with the Temperature Probe, without needing to enter a final food temperature. The probe will turn off the oven when it senses the preprogrammed final food temperature for the food category you chose.

1. **Perform Steps 1, 2, and 3 under “Cooking with the temperature probe.”**

2. Choose food category.

Keep touching AUTO ROAST until the desired food category appears on the Display. See “Auto roast chart” for categories.

Example for Roast Beef (medium rare):

TOUCH



(once)

YOU SEE

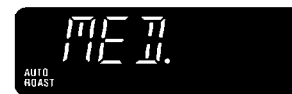

3. Start oven.

TOUCH



YOU SEE



continued on next page

MICROWAVE COOKING

When food temperature reaches 90°F:
The displayed temperature will change each time food temperature increases by 5°F. If the temperature does not change after 20 minutes, the Display will show "CHECK" and "PROBE."

When food reaches the desired temperature:

YOU SEE



YOU SEE



Auto roast chart

TOUCH AUTO ROAST	FOOD	SPECIAL INSTRUCTIONS
once	Roast Beef (medium rare)	Put tip of probe in center of largest muscle, but not touching fat or bone. Shield top of roast with aluminum foil, sauce, or vegetables. Cover roast with foil after cooking and let stand a few minutes.
twice	Roast Beef (medium)	Put tip of probe in center of largest muscle, but not touching fat or bone. Shield top of roast with aluminum foil, sauce, or vegetables. Cover roast with foil after cooking and let stand a few minutes.
three times	Roast Beef (well)	Put tip of probe in center of largest muscle, but not touching fat or bone. Shield top of roast with aluminum foil, sauce, or vegetables. Cover roast with foil after cooking and let stand a few minutes.
four times	Roast Pork (well)	Put tip of probe in center of largest muscle, but not touching fat or bone. Shield top of roast with aluminum foil, sauce, or vegetables. Cover roast with foil after cooking and let stand a few minutes.
five times	Poultry	Shield the wing tips with aluminum foil. Check with thermometer in 2-3 places to ensure adequate doneness.
six times	Slow Cook/ Simmer	Balance probe on wooden spoon or spatula so tip of probe is in center of liquid.

NOTE: Food to be roasted must be no less than .1 lb and no more than 9.9 lbs.

Using AUTO START

AUTO START lets you program your oven to begin cooking automatically at a time of day you choose. You can preprogram your oven up to 11 hours, 59 minutes in advance.

NOTES:

- **If you hear** the fan start when you touch START/ENTER, you have not set the oven properly. Touch OFF/CANCEL and start over.
- **You can use** AUTO START with high power or lower power cooking, temperature probe cooking, and WARM HOLD.
- **Do not use** foods containing baking powder or yeast when using AUTO START. They will not rise properly.

⚠ WARNING

Food Poisoning Hazard

Do not let food sit in oven more than one hour before or after cooking.

Doing so can result in death, food poisoning, or sickness.

1. **Put food in oven and close the door.**
-
2. **Make sure clock is set to correct time of day.**

continued on next page

MICROWAVE COOKING

3. Choose setting.

TOUCH



YOU SEE



4. Set start time.

Example for 4:30:

TOUCH



YOU SEE

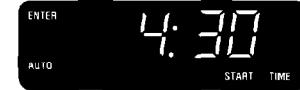

5. Enter cooking instructions for the function you want.

(cooking at high power or lower power, temperature probe cooking, WARM HOLD)

Example when cooking time is 4 minutes, 30 seconds:

TOUCH



YOU SEE



TOUCH



YOU SEE

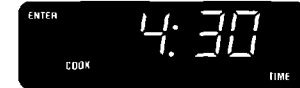

6. Complete entry.

Example when time of day is 12 o'clock:

TOUCH



YOU SEE



(time of day)

The oven will start cooking at the set time.

NOTE: If the door is opened before the start time is reached, the Display will show "DOOR" and "OPEN" until the door is closed. You must touch START/ENTER to resume AUTO START.

At end of cooking time:

YOU SEE

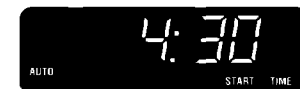

YOU SEE



Using SENSOR COOK

SENSOR COOK lets you cook common microwave-prepared foods without needing to program times and Cook Powers. A sensor in your oven detects the humidity released by the food, and the amount of humidity detected tells the oven how long to cook your food. SENSOR COOK has preset Cook Powers for seven categories: Frozen Entree, Casserole, Rice, Baked Potato, Fresh Vegetables, Frozen Vegetables, and Canned Vegetables. All you do is touch the SENSOR COOK pad the desired number of times and START/ENTER. Your microwave oven does the rest.

Refer to the following chart to choose a category:

CATEGORY	TOUCH SENSOR COOK
Frozen Entree (10-20 oz)	once
Casserole (1-4 cups at refrigerated temperature)	twice
Rice (½-2 cups)	three times
Baked Potato (1-4)	four times
Fresh Vegetables (1-4 cups)	five times
Frozen Vegetables (1-4 cups)	six times
Canned Vegetables (1-4 cups)	seven times

NOTE: See the "Microwave cooking chart" for cooking with cooking time and Cook Power.

1. Put food in oven and close the door.

2. Choose food category.

Example for food category 2 (Casserole):

TOUCH



(twice)

YOU SEE



3. Start oven.

TOUCH



YOU SEE



When oven detects a certain amount of humidity from food, cooking time is displayed.

YOU SEE

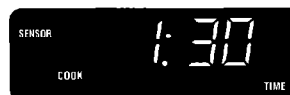

(this time will vary)

At end of cooking time:

YOU SEE



Using PIZZA REHEAT

PIZZA REHEAT lets you heat or reheat pizza by touching just one pad. A sensor in your oven detects the humidity released by the pizza, and the amount of humidity detected tells the oven how long to heat your pizza.

1. Place pizza on a paper towel and close the door.

2. Choose PIZZA REHEAT.

When oven detects a certain amount of humidity from the pizza, heating time is displayed.

Example:

At end of heating time:

TOUCH

PIZZA
REHEAT

YOU SEE

SENSOR
REHEAT P12 2A

YOU SEE

SENSOR
REHEAT 1:30 TIME

(this time will vary)

YOU SEE

SENSOR
REHEAT END

Using REHEAT

REHEAT lets you reheat food by touching just one pad. A sensor in your oven detects the humidity released by the food, and the amount of humidity detected tells the oven how long to heat your food. REHEAT has three preset categories: Plate, Soup/Sauce, and Casserole. All you do is touch REHEAT the desired number of times and your microwave oven does the rest.

NOTE: See the “Reheating chart” for reheating with cooking time and Cook Power.

Refer to the following chart to choose a category:

CATEGORY	TOUCH REHEAT
Plate (8 or 16 oz at refrigerated temperature)	once
Soup/Sauce (1-4 cups at room temperature)	twice
Casserole (1-4 cups at refrigerated temperature)	three times

1. Place food in oven and close the door.

2. Touch REHEAT to choose food category (once for Plate, twice for Soup/Sauce, three times for Casserole).

Example for Plate:

After 3 seconds, your oven will begin heating. When oven detects a certain amount of humidity from food, heating time is displayed. Example:

At end of heating time:

TOUCH



(once)

YOU SEE



YOU SEE

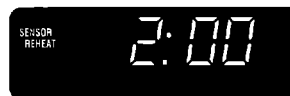

(this time will vary)

YOU SEE



Using POPCORN

POPCORN lets you pop commercially packaged microwave popcorn by touching just one pad. A sensor in your oven detects the humidity released by the popcorn, and the amount of humidity detected tells the oven how long to cook.

Pop only one package at a time. If you are using a microwave popcorn popper, follow manufacturer's instructions.

Cooking performance may vary with brand and fat content. Try several brands to decide which gives best popping results. For best results, use fresh bags of popcorn.

1. Place bag in oven and close the door.

2. Choose POPCORN.

After "CORN" is displayed for 3 seconds, your oven will begin heating.

At end of popping time:

! WARNING



Fire Hazard

Do not repop unpopped kernels.

Do not reuse popcorn bags.

Doing so can result in death, fire, or burns.

TOUCH



YOU SEE



and



YOU SEE



and



YOU SEE



Using ADD MINUTE

ADD MINUTE lets you cook food for 1 minute at 100% Cook Power or add an extra minute to your cooking cycle. You can also use it to extend cooking time in multiples of 1 minute, up to 99 minutes.

NOTES:

- **To extend** cooking time in multiples of 1 minute, touch ADD MINUTE repeatedly during cooking.
- **You can enter** ADD MINUTE only after closing the door, after touching OFF/CANCEL, or during cooking.
- **If you touch** ADD MINUTE during cooking, the oven will cook at the currently selected Cook Power. If you touch ADD MINUTE after cooking is over, the oven will cook at 100% Cook Power.
- **You cannot use** ADD MINUTE with POPCORN, AUTO ROAST, REHEAT, PIZZA REHEAT, SENSOR COOK, or AUTO DEFROST.
- **You cannot use** ADD MINUTE to start the oven if any program, other than the Minute Timer, is on the Display.

1. Make sure food is in the oven.

2. Choose ADD MINUTE.

Example for cooking for 1 minute:

TOUCH



YOU SEE

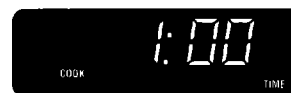

Adding or subtracting cook time

If a preset cook time is too long or too short, you can increase or decrease the cook time by 10% after choosing the function. You can only increase or decrease cook time before cooking starts.

To increase cook time by 10%:

TOUCH

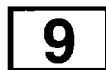

YOU SEE



(example for sensor cook)

To decrease cook time by 10%:

TOUCH



YOU SEE



To reset to the original cook time:

TOUCH

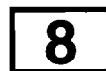

YOU SEE



Convection Cooking

This section gives you instructions for operating each convection function. Please read these instructions carefully.

How convection cooking works

Convection cooking circulates hot air through the oven cavity with a fan. The constantly moving air surrounds the food to heat the outer portion quickly. Your oven uses convection cooking whenever you use the Convection Command Pads.

Helpful hints for convection cooking:

- **Do not cover** baking rack with aluminum foil. It interferes with the flow of air that cooks the food.
- **Round pizza pans** are excellent cookware for many convection-only items. Choose pans that do not have extended handles.
- **Use convection cooking** for items like souffles, breads, cookies, angel food cakes, pizza, and for some meat and fish cooking.
- **You do not need to use** any special techniques to adapt your favorite oven recipes to convection cooking; however, you may need to lower some temperatures or reduce some cooking times from the convection oven cooking directions. See examples in your cookbook and in the charts in this section.
- **When baking** cakes, cookies, breads, rolls, or other baked foods, most recipes call for preheating. Preheat the empty oven just as you do a regular oven. You can start heavier dense foods such as meats, casseroles, and poultry without preheating.
- **All heatproof** cookware or metal utensils can be used in convection cooking.
- **As in conventional cooking**, the distance of the food from the heat source affects cooking results. Follow cookbook recipes and refer to the charts in this Use and Care Guide. It is also helpful to find a similar recipe in the cookbook index and to refer to recipe's suggested techniques.
- **Use metal cookware** only for convection cooking. Never use for microwave or combination cooking since arcing and damage to the oven may occur.
- **After preheating**, if you do not open the door, the oven will automatically hold at the preheated temperature for 30 minutes.
- **You can set** up to three convection cycles. (Example for two-crust pies: you can set the oven to preheat for baking at 425°F and to finish baking at 350°F.)

! WARNING

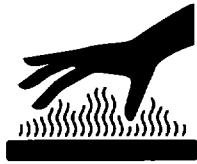

Burn Hazard

Use oven mitts to remove items from microwave.

Do not touch areas near oven vent openings during use.

Failure to follow these instructions can result in burns.

NOTE: Use cookware that will not melt or burn in the hot oven. Do not use light plastic containers, plastic wraps, or paper products during any convection combination cycle.

Convection baking without preheating (meats, casseroles, and poultry)

1. Put food in oven and close the door.

2. Choose setting.

Oven will automatically cook at 350°F:

TOUCH
CONVECTION

BAKE

YOU SEE



3. Set baking temperature
(optional).

You can enter a temperature between 150°F and 450°F. Example for 325°F:

NOTE: To clear the temperature you entered, touch CONVECTION BAKE before entering a bake time. You can then re-enter the cooking temperature, if desired.

TOUCH

3

2

5

YOU SEE



continued on next page

CONVECTION COOKING

4. Set cooking time.

Three seconds after entering bake temperature:

You can enter a time up to 199 minutes, 99 seconds.

Example for 20 minutes:

TOUCH

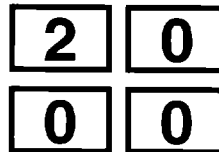

YOU SEE



YOU SEE



5. Start oven.

NOTE: You can see the cooking temperature anytime during cooking by touching CONVECTION BAKE. Cooking temperature will show for 3 seconds.

At end of cooking time:

TOUCH



YOU SEE



(time will count down)

YOU SEE



Convection baking with preheating

1. Choose setting.

TOUCH
CONVECTION



YOU SEE



2. Set preheat/cooking temperature.

TOUCH
CONVECTION



YOU SEE



CONVECTION COOKING

The oven will automatically preheat/cook at 350°F. If you want to change the preheat/cooking temperature, follow the example below. If you want to preheat/cook at 350°F, go to Step 3.

Example for 325°F:

TOUCH

3

2

5

YOU SEE



3. Set cooking cycle cooking time.

Three seconds after entering bake temperature:

You can enter a time up to 199 minutes, 99 seconds.

Example for 20 minutes:

YOU SEE



TOUCH

2 0

0 0

YOU SEE



4. Start oven.

When the oven temperature reaches 150°F, the temperature will be displayed. The displayed temperature will change each time temperature goes up by five degrees.

NOTES:

- **If you open** the door during preheating, preheating will stop. To resume preheating after you open the door, close the door and touch START/ENTER.
- **When the oven reaches** the set preheat temperature, two tones will sound and the oven will automatically hold that temperature for 30 minutes. The Display will show the set temperature.

TOUCH



YOU SEE



(display shows oven is preheating)

continued on next page

CONVECTION COOKING

5. After preheating, open the door, put food in oven, and close the door.

NOTE: You can see the cooking temperature anytime during cooking by touching CONVECTION BAKE. The cooking temperature will show for 3 seconds.

At end of cooking time:

TOUCH



YOU SEE



(time for cook cycle will count down)

YOU SEE



Convection broiling

1. Choose setting.

TOUCH

CONVECTION



YOU SEE



2. Set cooking cycle cooking time.

You can enter a time up to 199 minutes, 99 seconds.

Example for 20 minutes:

TOUCH

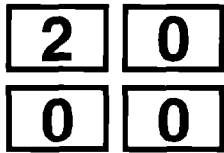

YOU SEE



3. Start oven.

NOTES:

- **Oven will preheat** to 450°F. When the oven temperature reaches 150°F, the temperature will be displayed. The displayed temperature will change each time temperature goes up by five degrees.
- **If you open** the door during preheating, preheating will stop. To resume preheating after you open the door, close the door and touch START/ENTER.
- **When the oven reaches** the set preheat temperature, two tones will sound and the oven will automatically hold that temperature for 30 minutes. The Display will show the set temperature.

TOUCH



YOU SEE



(display shows oven is preheating)

4. After preheating, open the door, put food in oven, and close the door.

NOTE: You can see the cooking temperature anytime during cooking by touching CONVECTION BAKE. The cooking temperature will show for 3 seconds.

At end of cooking time:

TOUCH



YOU SEE



(time for cook cycle will count down)

YOU SEE



CONVECTION COOKING

Convenience foods cooking chart

Convection cooking of convenience foods is similar to cooking in a conventional oven. Select items that fit conveniently on the turntable, such as an 8 $\frac{1}{2}$ -inch frozen pizza. Convection preheat to the desired temperature, and use metal or ovenproof glass cookware. When cooking or baking these convenience foods, follow package

directions for preparation and selecting the correct container. Because of the great variety of foods available, times given here are approximate. It is advisable to always check food about 5 minutes before the minimum recommended time, and cook longer only if needed. Use oven mitts to insert or remove items from the oven.

FOOD	SIZE/WT	COOKING MODE	COOKING TIME	SPECIAL INSTRUCTIONS
Pizza (frozen)	13 ounces (8 $\frac{1}{2}$ inch)	CONVECTION 400°F (preheated)	14-16 minutes	Cook directly on Bi-Level Metal Rack for crisper crust.
Brownies	20 ounces	CONVECTION 350°F (preheated)	23-26 minutes	Bake in 9-inch square pan on Bi-Level Metal Rack.
Frozen Double Crust Pie	26 ounces	CONVECTION 425°F (preheated) then 350°F	30 minutes 30-35 minutes	Bake in metal or ovenproof pan on Bi-Level Metal Rack.
Cake Layers	18-25 ounces	CONVECTION 350°F (preheated)	20 minutes	Bake one layer at a time on Bi-Level Metal Rack.
Apple Sauce Cake	18-25 ounces	CONVECTION 350°F (preheated)	30-35 minutes	Use metal 10-cup fluted tube pan on Bi-Level Metal Rack.
Date Nut Bread	17 ounces	CONVECTION 350°F (preheated)	40 minutes	Bake in 9 x 5-inch metal loaf pan on Bi-Level Metal Rack.
Frozen Bread Dough	16 ounces	CONVECTION 375°F (preheated)	25-30 minutes	Follow package directions for thawing and proofing dough. Bake in metal greased 8 $\frac{1}{2}$ x 4 $\frac{1}{2}$ x 2 $\frac{1}{2}$ -inch loaf pan on Bi-Level Metal Rack.
Refrigerated Cookies	20 ounces	CONVECTION 350°F (preheated)	8-9 $\frac{1}{2}$ minutes	Bake six at a time on metal round cookie sheet on Bi-Level Metal Rack.

NOTE: Use the bottom position when cooking with the Bi-Level Metal Rack. (See the "Using the bi-level metal rack" section.)

Convection cooking with the temperature probe

The Temperature Probe helps take the guesswork out of cooking roasts and larger casseroles. The probe is designed to turn off the oven when it senses the temperature you chose (between 90°F and 200°F). See your cookbook for helpful information on cooking different types of food.

NOTES:

- If you have not plugged in the Temperature Probe properly or if probe is defective, "PROBE" will appear on the Display, three tones will sound, and the oven will not turn on.
- For correct probe temperatures for different foods, see the "Temperature probe convection cooking chart."

1. Insert probe into food.

Insert at least 1/3 of the Temperature Probe into the food. (See "Temperature probe cooking tips" in the "Microwave Cooking" section.)

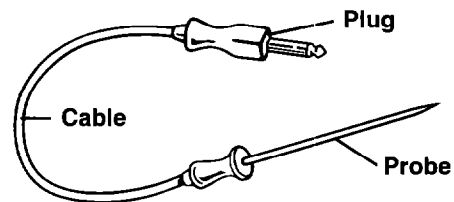

2. Place food in oven and plug probe into socket on oven wall.

Make sure the probe does not touch any part of the oven interior – including the rack.

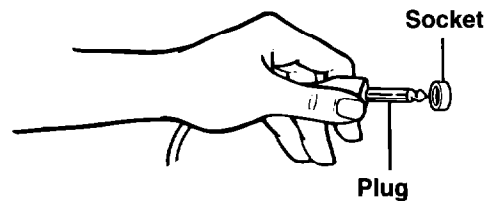

3. Close the door.

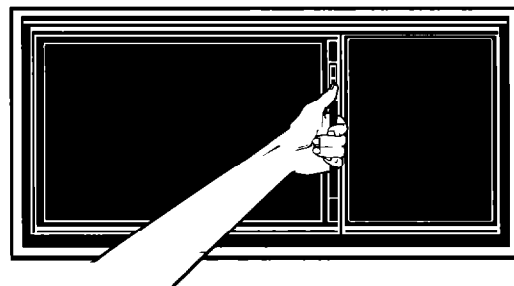

4. Choose temperature probe setting.

The oven will automatically heat to a final food temperature of 160°F. If you want to change the final food temperature, follow Step 5. If you want a final food temperature of 160°F, skip to Step 6.

TOUCH

**PROBE
TEMP**

YOU SEE



continued on next page

CONVECTION COOKING

5. Set desired final food temperature (optional).

Example for 150°F:

TOUCH

1

5

0

YOU SEE



6. Set convection cooking temperature.

The oven will automatically cook at 350°F. If you want to change the cooking temperature, follow the example below. If you want to cook at 350°F, go to Step 7.

Example for 325°F:

TOUCH

CONVECTION

BAKE

TOUCH

3

2

5

YOU SEE



YOU SEE



7. Start oven.

When food temperature reaches 90°F, the Display will show the actual temperature of the food as it increases to the desired temperature.

When food reaches desired temperature:

TOUCH

START

ENTER 

YOU SEE



YOU SEE



Temperature probe convection cooking chart

FOOD	OVEN TEMP	FIRST STAGE	SECOND STAGE		SPECIAL NOTES
		TIME	TIME	or PROBE TEMP	
Beef Meat Loaf (1½-1¾ lbs)	350°F		35 min	160°F	Preheat. Let stand 5-10 min.
Beef Rib Roast, boneless	350°F	5 min per lb Turn over	6 min per lb	Rare: 120°F Med: 130°F	Cook in microwave-proof and heatproof dish with Bi-Level Metal Rack. Let stand 10 min after cooking (covered).
Beef Rib Roast, with bone (5 lbs)	350°F	7 min per lb Fat-side down Turn over	8-10 min per lb	Rare: 120°F Med: 130°F Well: 140°F	Cook in microwave-proof and heatproof dish. Let stand 10 min after cooking (covered).
Beef Pot Roast, boneless (3 lbs)	350°F	7 min per lb Turn over	8-10 min per lb	Med: 130°F Well: 140°F	Cook in covered microwaveproof and heatproof casserole or cooking bag.
Lamb Lamb Leg or Shoulder Roast, with bone (6½ lbs)	350°F	4 min per lb Fat-side down Turn over	5-7 min per lb	Rare: 145°F Med: 155°F Well: 165°F	Cook in microwave-proof and heatproof dish with Bi-Level Metal Rack. Let stand 10 min after cooking (covered).
Lamb Roast, boneless (3-4 lbs)	350°F	5 min per lb Fat-side down Turn over	4-6 min per lb	150°F	Cook in microwave-proof and heatproof dish with Bi-Level Metal Rack. Let stand 10 min after cooking (covered).

NOTE: Use the bottom position when cooking with the Bi-Level Metal Rack. (See the "Using the bi-level metal rack" section.)

continued on next page

CONVECTION COOKING

FOOD	OVEN TEMP	FIRST STAGE	SECOND STAGE		SPECIAL NOTES
		TIME	TIME	or PROBE TEMP	
Veal Shoulder or Rump Roast, boneless (3-3½ lbs)	325°F	4-5 min per lb Turn over	4-6 min per lb	155°F	Cook in microwave-proof and heatproof dish with Bi-Level Metal Rack. Let stand 10 min after cooking (covered).
Pork Pork Loin Roast, boneless (4-5 lbs)	350°F	5-7 min per lb Turn over	6-8 min per lb	165°F	Cook in microwave-proof and heatproof baking dish. Let stand 10 min after cooking (covered).
Pork Loin, center cut (4-5 lbs)	350°F	5-7 min per lb Turn over	6-8 min per lb	165°F	Cook in microwave-proof and heatproof baking dish. Let stand 10 min after cooking (covered).

Combination Cooking

This section gives you instructions for operating each combination cooking function. Please read these instructions carefully.

How combination cooking works

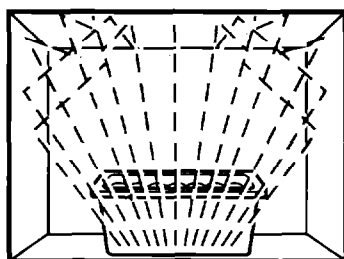

Microwave

+

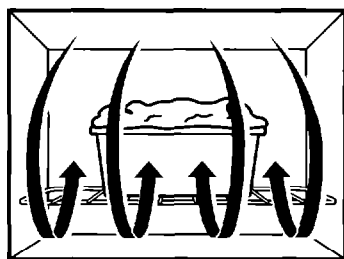

Convection

=

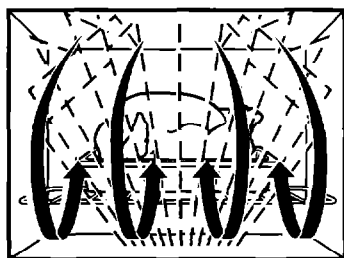

Combination microwave/convection

Sometimes combination microwave-convection cooking is suggested to get the proper cooking results. It shortens the cooking time for foods that normally need a long time to cook. This cooking process also leaves meats juicy on the inside and crispy on the outside. In combination cooking, the convection heat and microwave energy alternate automatically. Your oven has two pre-programmed settings that make it easy to cook with both convection heat and microwave energy automatically.

Helpful hints for combination cooking:

- **Meats** may be roasted directly on the Bi-Level Metal Rack or in a shallow roasting pan placed on the rack. When using the Bi-Level Metal Rack, please check your cookbook for information on proper use.
- **Less tender** cuts of beef can be roasted and tenderized using oven cooking bags.
- **When baking**, check for doneness after cooking time is up. If not completely done, let stand in oven for a few minutes to complete cooking.

NOTE: During combination baking, some bakeware may cause arcing when it comes in contact with the oven walls or metal accessory racks. Arcing is a discharge of electricity that occurs when microwaves come in contact with metal. If arcing occurs, place a heatproof dish between the pan and the Bi-Level Metal Rack. If arcing occurs with other bakeware, stop using them for combination cooking.

Combination baking/roasting without preheating

1. Put food in oven and close the door.

2. Choose setting.

Example for baking:

The oven will automatically cook at 350°F for combination baking and 300°F for combination roasting. If you want to change the cooking temperature, follow Step 3 below. If you want to cook at the default temperature, skip Step 3 below.

TOUCH
COMBINATION

BAKE

YOU SEE



3. Set baking/roasting temperature (optional).

Example for 325°F:

NOTE: To clear the temperature you entered, touch COMBINATION BAKE (when baking) or COMBINATION ROAST (when roasting) before entering a cooking time. You can then re-enter the cooking temperature, if desired.

TOUCH

3

2

5

YOU SEE



4. Set cooking time.

One second after entering cook temperature:

You can enter a time up to 199 minutes, 99 seconds.

Example for 20 minutes:

YOU SEE



TOUCH

2

0

0

0

YOU SEE



5. Start oven.

NOTE: You can see the cooking temperature anytime during cooking by touching COMBINATION BAKE (when baking) or COMBINATION ROAST (when roasting). Cooking temperature will show for 3 seconds.

TOUCH

START

ENTER

YOU SEE



(time will count down)

COMBINATION COOKING

At end of cooking time:

YOU SEE



Combination baking/roasting with preheating

1. Choose setting.

Example for roasting:

TOUCH
COMBINATION



YOU SEE



2. Set preheat/cooking temperature.

The oven will automatically cook at 350°F for combination baking and 300°F for combination roasting. If you want to change the preheat/cooking temperature, follow the example below. If you want to preheat/cook at the default temperature, go to Step 3.

Example for 325°F:

TOUCH
COMBINATION



YOU SEE



TOUCH

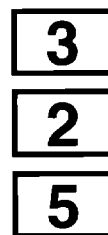

YOU SEE



3. Set cooking cycle cooking time.

One second after entering cook temperature:

You can enter a time up to 199 minutes, 99 seconds.

Example for 20 minutes:

YOU SEE



TOUCH

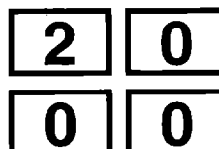

YOU SEE



continued on next page

COMBINATION COOKING

4. Start oven.

When the oven temperature reaches 150°F, the temperature will be displayed. The displayed temperature will change each time temperature goes up by five degrees.

NOTES:

- **If you open** the door or touch OFF/CANCEL during preheating, preheating will stop. To resume preheating, close the door and touch START/ENTER.
- **When the oven reaches** the set preheat temperature, two tones will sound and the oven will automatically hold that temperature for 30 minutes. The Display will show the set temperature.

TOUCH



YOU SEE



(display shows oven is preheating)

5. After preheating, open the door, put food in oven, and close the door.

NOTE: You can see the cooking temperature anytime during cooking by touching COMBINATION BAKE (when baking) or COMBINATION ROAST (when roasting). The cooking temperature will show for 3 seconds.

At end of cooking time:

TOUCH



YOU SEE



(time for cook cycle will count down)

YOU SEE



Combination cooking with the temperature probe

The Temperature Probe helps take the guesswork out of cooking roasts and larger casseroles. The probe is designed to turn off the oven when it senses the temperature you chose (between 90°F and 200°F). See your cookbook for helpful information on cooking different types of food.

NOTES:

- **If you have not plugged in** the Temperature Probe properly or if probe is defective, “PROBE” will appear on the Display, three tones will sound, and the oven will not turn on.
- **For correct probe temperatures** for different foods, see the “Temperature probe combination cooking chart” in this section.

1. Insert probe into food.

Insert at least 1/3 of the Temperature Probe into the food. (See “Temperature probe cooking tips” in the “Microwave Cooking” section.)

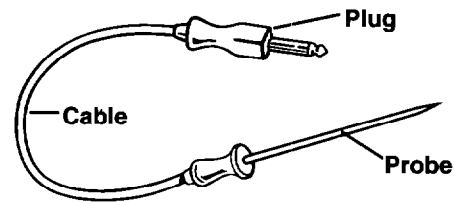

2. Place food in oven and plug probe into socket on oven wall.

Make sure the probe does not touch any part of the oven interior – including the rack.

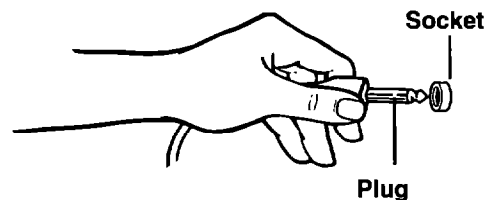

3. Close the door.

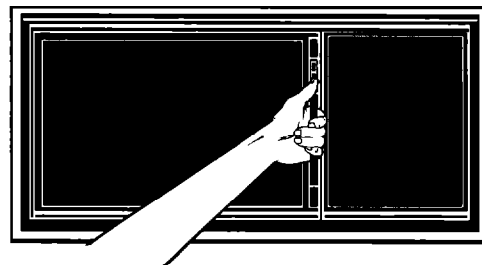

4. Choose temperature probe setting.

The oven will automatically heat to a final food temperature of 160°F. If you want to change the final food temperature, follow Step 5. If you want a final food temperature of 160°F, skip to Step 6.

TOUCH



YOU SEE



continued on next page

COMBINATION COOKING

5. Set desired final food temperature (optional).

Example for 150°F:

TOUCH

1

5

0

YOU SEE



ENTER 150°F
TEMP PROBE COMB

6. Set combination cooking temperature.

The oven will automatically cook at 350°F (when baking) or 300°F (when roasting). If you want to change the cooking temperature, follow the example below. If you want to cook at the default temperature, go to Step 7.

Example for 325°F:

TOUCH

COMBINATION

BAKE

YOU SEE



ENTER 350°F
TEMP PROBE COMB

TOUCH

3

2

5

YOU SEE



ENTER 325°F
TEMP PROBE COMB

7. Start oven.

When food temperature reaches 150°F, the Display will show the actual temperature of the food as it increases to the desired temperature.

When food reaches desired temperature:

TOUCH

START

ENTER 

YOU SEE



ENTER LOF
TEMP PROBE COMB COOK

YOU SEE



ENTER END
TEMP PROBE COMB COOK

Temperature probe combination cooking chart

FOOD	OVEN TEMP	FIRST STAGE	SECOND STAGE		SPECIAL NOTES
		TIME	TIME	or PROBE TEMP	
Beef Meat Loaf (1½-1¾ lbs)	350°F		35 min	160°F	Preheat. Let stand 5-10 min.
Beef Rib Roast, boneless	350°F	5 min per lb Turn over	6 min per lb	Rare: 120°F Med: 130°F	Cook in microwave-proof and heatproof dish with Bi-Level Metal Rack. Let stand 10 min after cooking (covered).
Beef Rib Roast, with bone (5 lbs)	350°F	7 min per lb Fat-side down Turn over	8-10 min per lb	Rare: 120°F Med: 130°F Well: 140°F	Cook in microwave-proof and heatproof dish. Let stand 10 min after cooking (covered).
Beef Pot Roast, boneless (3 lbs)	350°F	7 min per lb Turn over	8-10 min per lb	Med: 130°F Well: 140°F	Cook in covered microwave-proof and heatproof casserole or cooking bag.
Lamb Lamb Leg or Shoulder Roast, with bone (6½ lbs)	350°F	4 min per lb Fat-side down Turn over	5-7 min per lb	Rare: 145°F Med: 155°F Well: 165°F	Cook in microwave-proof and heatproof dish with Bi-Level Metal Rack. Let stand 10 min after cooking (covered).

continued on next page

COMBINATION COOKING

FOOD	OVEN TEMP	FIRST STAGE	SECOND STAGE		SPECIAL NOTES
		TIME	TIME	or PROBE TEMP	
Lamb Roast, boneless (3-4 lbs)	350°F	5 min per lb Fat-side down Turn over	4-6 min per lb	150°F	Cook in microwave-proof and heatproof dish with Bi-Level Metal Rack. Let stand 10 min after cooking (covered).
Veal Shoulder or Rump Roast, boneless (3-3½ lbs)	325°F	4-5 min per lb Turn over	4-6 min per lb	155°F	Cook in microwave-proof and heatproof dish with Bi-Level Metal Rack. Let stand 10 min after cooking (covered).
Pork Pork Loin Roast, boneless (4-5 lbs)	350°F	5-7 min per lb Turn over	6-8 min per lb	165°F	Cook in microwave-proof and heatproof baking dish. Let stand 10 min after cooking (covered).
Pork Loin, center cut (4-5 lbs)	350°F	5-7 min per lb Turn over	6-8 min per lb	165°F	Cook in microwave-proof and heatproof baking dish. Let stand 10 min after cooking (covered).

Caring for Your Microwave Oven

To make sure your microwave oven looks good and works well for a long time, you should maintain it properly. For proper care, please follow these instructions carefully.

Cleaning the microwave oven

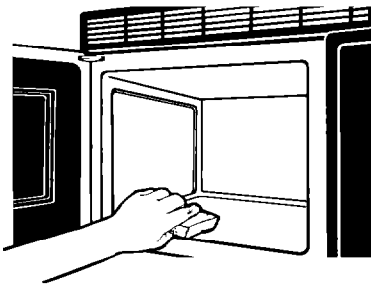

For interior surfaces: Wash often with warm, sudsy water and a sponge or soft cloth. Use only mild, nonabrasive soaps or a mild detergent. Be sure to keep the areas clean where the door and oven frame touch when closed. Wipe well with clean water.

For exterior surfaces and control panel: Use a soft cloth with spray glass cleaner. Apply spray glass cleaner to soft cloth, do not spray directly on oven.

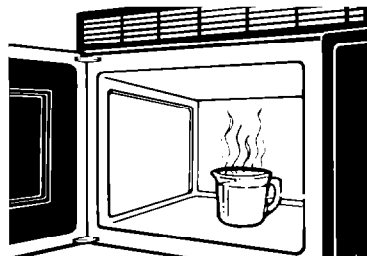

For stubborn soil, **boil** a cup of water in the oven for two or three minutes. Steam will soften the soil. To get rid of odors inside the oven, **boil** a cup of water with lemon juice or vinegar.

NOTE: Abrasive cleansers, steel-wool pads, gritty wash cloths, some paper towels, etc., can damage the control panel and the interior and exterior oven surfaces.

Cleaning the bi-level metal rack

- Wash by hand with a mild detergent and a soft or nylon scrub brush. Dry completely.
- Do not use abrasive scrubbers or cleansers to clean rack.

Caring for the filters

Do not allow grease and soil to build up in the grease filters. It will decrease the exhaust fan efficiency. Remove and clean grease filters at least once a month. When you have removed a grease filter or a charcoal filter remember to replace the filter before you operate the hood.

⚠ WARNING



Electrical Shock Hazard

Disconnect power before removing vent cover.

Replace all panels before operating.

Failure to do so can result in death or electrical shock.

Before removing filters:

- Unplug power cord or turn off power supply.

Grease filters:

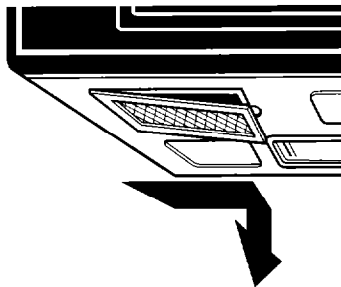

1. To remove grease filters, slide each filter to the side. Pull filters downward and push to the other side. The filter will drop out.

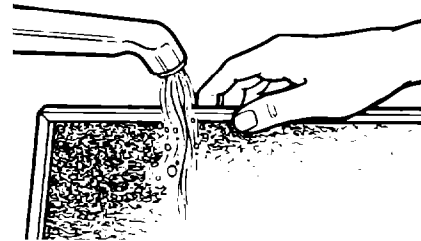

2. Soak grease filters in hot water and a mild detergent. **Scrub and swish** to remove embedded dirt and grease. **Rinse well and shake to dry.** Do not clean filters with ammonia, corrosive cleaning agents such as lye-based oven cleaners, or place them in a dishwasher. The filters will turn black or could be damaged.

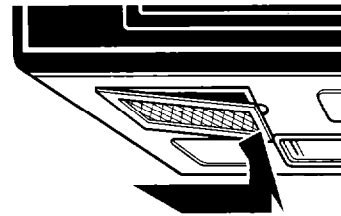

3. To replace grease filters, slide filter in the frame slot on one side of the opening. **Push** filter upward and **push** to the other side to lock into place.

CARING FOR YOUR MICROWAVE OVEN

Charcoal filter:

If your microwave hood combination is installed to recirculate air, replace the charcoal filter every 6-12 months. The charcoal filter cannot be cleaned. Replacement charcoal filters are available from your authorized Whirlpool service company, Part No. 4359416, or by calling the Consumer Assistance Center at 1-800-253-1301.

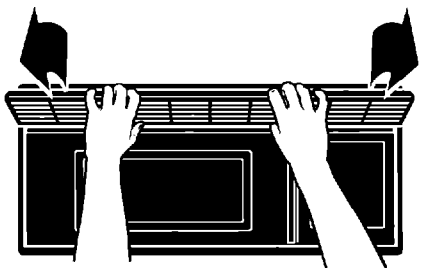

1. **If you need** to remove an existing charcoal filter, **remove** the vent cover mounting screws.
2. **Tip** the cover forward, then **lift out** to remove.

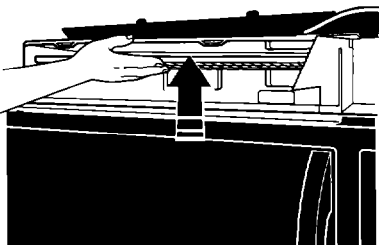

3. **Lift** the back of the charcoal filter. **Slide** the filter straight out.

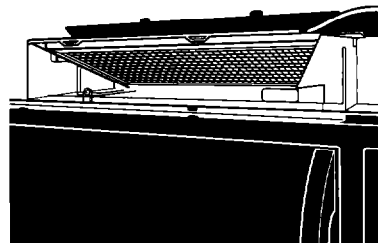

4. **Slide** a new charcoal filter into place. The filter should rest at the angle shown.

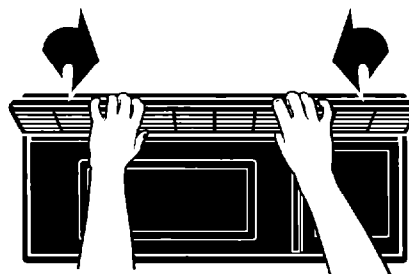

5. **Slide** the bottom of the vent cover into place. **Push** the top until it snaps into place. **Replace** the mounting screws.

After replacing filters:

- Plug in power cord or turn on power supply.

Replacing the cooktop and oven lights

⚠ WARNING



Fire Hazard

Use only candelabra-base bulbs, 30-watt maximum.

Turn off power at main power supply before replacing the light bulb.

Failure to follow the above could result in fire or electrical shock.

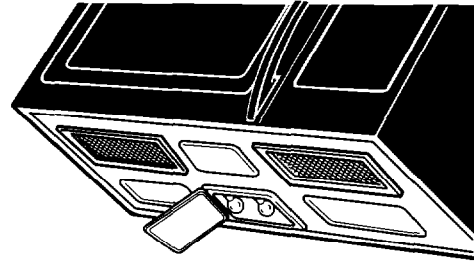

2. **Remove** the bulb cover mounting screws.
3. We recommend replacing bulb(s) with candelabra-base 30-watt bulb(s) available from your authorized Whirlpool service company (Part No. 4158432).
4. **Turn** the power back on at the main power supply.

The cooktop light

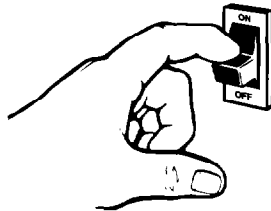

1. **Turn off** power at the main power supply.

The oven light

⚠ WARNING



Electrical Shock Hazard
Disconnect power before removing vent cover.
Replace all panels before operating.
Failure to do so can result in death or electrical shock.

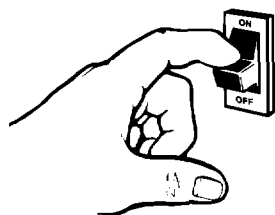

1. Turn off power at the main power supply.

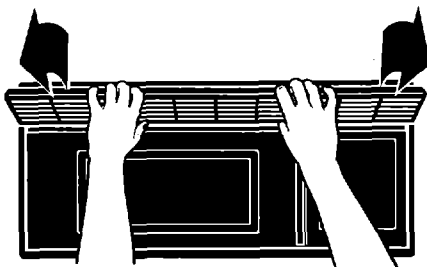

2. Remove the vent cover mounting screws.
3. Tip the cover forward, then lift out to remove.

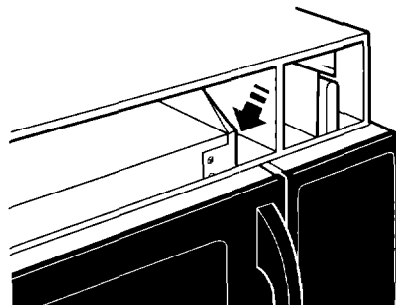

4. Remove bulb holder mounting screw.

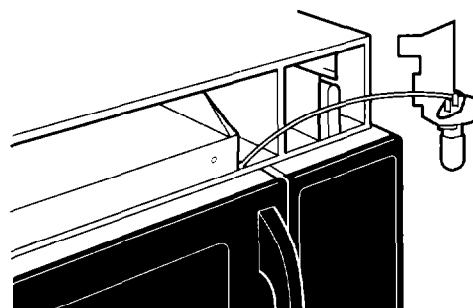

5. Lift up the bulb holder.
6. We recommend replacing the bulb with a candelabra-base 30-watt bulb available from your authorized Whirlpool service company (Part No. 4158432).
7. Replace the bulb holder and mounting screw.

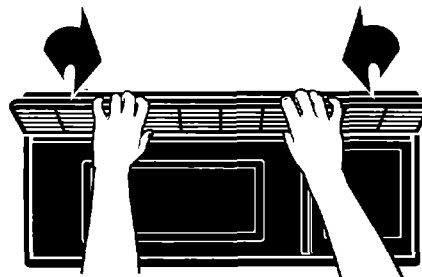

8. Slide the top of the vent cover into place. Push the bottom until it snaps into place. Replace the mounting screws. Turn the power back on at the main power supply.

Cooking Guide

Reheating chart

Times are approximate and may need to be adjusted to individual taste. **NOTE:** See "Using REHEAT" for instructions on how to reheat by touching just one Command Pad.

ITEM	STARTING TEMP	TIME/POWER	PROCEDURE
Meat (Chicken pieces, chops, hamburgers, meat loaf slices) 1 serving 2 servings	Refrigerated Refrigerated	1-2 min at 70% 2½-4½ min at 70%	Cover loosely.
Meat Slices (Beef, ham, pork, turkey) 1 or more servings	Room temp Refrigerated	45 sec-1 min per serving at 50% 1-3 min per serving at 50%	Cover with gravy or wax paper. Check after 30 sec per serving.
Stirrable Casseroles and Main Dishes 1 serving 2 servings 4-6 servings	Refrigerated Refrigerated Refrigerated	2-4 min at 100% 4-6 min at 100% 6-8 min at 100%	Cover. Stir after half the time.
Nonstirrable Casseroles and Main Dishes 1 serving 2 servings 4-6 servings	Refrigerated Refrigerated Refrigerated	5-8 min at 50% 9-12 min at 50% 13-16 min at 50%	Cover with wax paper.
Soup, Cream 1 cup 1 can (10¾ oz)	Refrigerated Room temp	3-4½ min at 50% 5-7 min at 50%	Cover. Stir after half the time.
Soup, Clear 1 cup 1 can (10¾ oz)	Refrigerated Room temp	2½-3½ min at 100% 4-5½ min at 100%	Cover. Stir after half the time.
Pizza 1 slice 1 slice 2 slices 2 slices	Room temp Refrigerated Room temp Refrigerated	15-25 sec at 100% 30-40 sec at 100% 30-40 sec at 100% 45-55 sec at 100%	Place on paper towel.
Vegetables 1 serving 2 servings	Refrigerated Refrigerated	¾-1½ min at 100% 1½-2½ min at 100%	Cover. Stir after half the time.
Baked Potato 1 2	Refrigerated Refrigerated	1-2 min at 50% 2-3 min at 50%	Cut potato lengthwise and then several times crosswise. Cover with wax paper.
Breads (Dinner or breakfast roll) 1 roll 2 rolls 4 rolls	Room temp Room temp Room temp	8-12 sec at 50% 11-15 sec at 100% 18-22 sec at 100%	Wrap single roll, bagel, or muffin in paper towel. To reheat several, line plate with paper towel. Cover with another paper towel.
Pie Whole 1 slice	Refrigerated Refrigerated	5-7 min at 70% 30 sec at 100%	Cover with paper towel.

Microwave cooking chart

Times are approximate and may need to be adjusted to individual taste. **NOTE:** See "Using SENSOR COOK" for instructions on how to cook without entering cooking times or Cook Powers.

MEATS, POULTRY, FISH, SEAFOOD			VEGETABLES (continued)		
Allow standing time after cooking.			Cook at 100% cook power.		
FOOD	COOK POWER	TIME	FOOD	TIME	
Bacon (per slice)	100%	45 sec to 1 min 15 sec per slice	Cauliflower (medium head)	6-9 min	
Ground Beef for Casseroles (1 lb)	100%	4-6 min	Corn on the Cob (2) (4)	4-9 min 6-16 min	
Hamburger Patties (2)	100%	1st side 2 min 2nd side 1½ to 2½ min	Potatoes, Baked (4 medium)	13-19 min	
Hamburger Patties (4)	100%	1st side 2½ min 2nd side 2-3 min	Squash, Summer (1 lb)	3-8 min	
Meat Loaf (1½ lbs)	100%	13-19 min	OTHER		
Chicken Pieces	100%	6-9 min/lb	FOOD	COOK POWER	TIME
Internal temperature should be 185°F after standing.			Applesauce (4 servings)	100%	7-10 min
Turkey Breast <u>then</u>	100% 70%	5 min 8-12 min/lb	Baked Apples (4)	100%	4-6 min
Internal temperature should be 185°F after standing.			Chocolate (melt 1 square)	50%	1-2 min
Fish Fillets (1 lb)	100%	5-6 min	Eggs, Scrambled (2)	100%	1 min 15 sec to 1 min 45 sec
Scallops and Shrimp (1 lb)	100%	3½-5½ min	(4)		2-3 min
VEGETABLES			Hot Cereals (1 serving) (4 servings)	100%	1½-5 min 4½-7 min
Cook at 100% cook power.			Nachos (large plate)	50%	1½-2½ min
FOOD	TIME		Water for Beverage (1 cup) (2 cups)	100%	2½-4 min 4½-6 min
Beans, Green or Yellow (1 lb)	6-12 min				
Broccoli (1 lb)	6-10 min				
Carrots (1 lb)	8-12 min				

Microwave cooking tips

Amount of food

- **If you increase or decrease** the amount of food you prepare, the time it takes to cook that food will also change. For example, if you double a recipe, add a little more than half the original cooking time. Check for doneness and, if necessary, add more time in small increments.
- **If you want to cook two meals or containers of food** at the same time, you can do so with the Bi-Level Metal Rack. For example, you can cook two frozen dinners or reheat two plates of food by placing one on the rack and one under the rack.

Starting temperature of food

- **The lower the temperature** of the food being put into the microwave oven, the longer it takes to cook. Food at room temperature will be reheated more quickly than food at refrigerator temperature.

Composition of food

- **Food with a lot of fat and sugar** will be heated faster than food containing a lot of water. Fat and sugar will also reach a higher temperature than water in the cooking process.
- **The more dense the food**, the longer it takes to heat. "Very dense" food like meat takes longer to reheat than lighter, more porous food like sponge cakes.

Size and shape

- **Smaller pieces of food** will cook faster than larger pieces and same-shaped pieces of food cook more evenly than irregularly-shaped foods.
- **With unevenly shaped foods**, the thinner parts will cook faster than the thicker areas. **Place** the thinner parts of chicken wings and legs in the center of the dish.

Stirring, turning foods

- **Stirring and turning foods** distributes heat quickly to the center of the dish and avoids overcooking at the outer edges of the food.

Covering food

Cover food to:

- **Reduce** splattering
- **Shorten** cooking times
- **Retain** food moisture

All coverings that allow microwaves to pass through are suitable.

Releasing pressure in foods

- **Several foods** (for example: baked potatoes, sausages, egg yolks, and some fruits) are tightly covered by a skin or membrane. This can cause the food to burst from steam building up in them during cooking. To relieve the pressure and to prevent bursting, **pierce** these foods before cooking with a fork, cocktail pick, or toothpick.

Using standing time

- **Always allow food to stand** for a while after cooking. Standing time after defrosting, cooking, or reheating always improves the result since the temperature will then be evenly distributed throughout the food.
- **The length of the standing time** depends on the volume and density of the food. Sometimes it can be as short as the time it takes you to remove the food from the oven and take it to the serving table. However, with larger, denser food, the standing time may be as long as 10 minutes.

Arranging food

For best results, distribute food evenly on the plate. You can do this in several ways:

- **If you are cooking several items of the same food**, such as baked potatoes, **place** them in a ring pattern for uniform cooking.
- **When cooking foods of uneven shapes or thickness, such as chicken breasts**, **place** the smaller or thinner area of the food towards the center of the dish where it will be heated last.
- **Layer** thin slices of meat on top of each other.
- **When you cook or reheat whole fish**, **score** the skin – this prevents cracking. Shield the tail and head of whole fish with small pieces of foil to prevent overcooking and ensure the foil does not touch the sides of the oven.
- **Do not** let food or container touch the top or sides of the oven. This will prevent possible arcing.

Using aluminum foil

Metal containers should not be used in a microwave oven. There are, however, some exceptions. If you have purchased food which is prepackaged in an aluminum foil container, then refer to the instructions on the package. When using aluminum foil containers, cooking times may be longer because microwaves will only penetrate the top of the food.

If you use aluminum containers without package instructions, follow these guidelines:

- **Place** container in a glass bowl and add some water so that it covers the bottom of the container, not more than ¼-inch high. This ensures even heating of the container bottom.
- **Always remove** the lid to avoid damage to the oven.
- **Use only** undamaged containers.
- **Do not use** containers taller than ¾-inch.
- **Container must be** half filled.
- **To avoid arcing**, there must be a minimum ¼-inch between the aluminum container and the walls of the oven and also between two aluminum containers.
- **Reheating food** in aluminum foil containers usually takes up to double the time compared to reheating in plastic, glass, china, or paper containers. The time when food is ready will vary a great deal.
- **Let food stand** for 2-3 minutes after heating so that heat is spread evenly throughout container.

Cooking you should not do in your microwave oven

- **Do not** do canning of foods in the oven. Closed glass jars may explode, resulting in damage to the oven or possible personal injury.
- **Do not** use the microwave oven to sterilize objects (baby bottles, etc.). It is difficult to maintain the high temperature required for safe sterilization.

Oven cookware guide

You can use a variety of cookware and materials in your microwave-convection oven. For your safety and to prevent damage to cookware and your oven, choose appropriate cookware and materials for each cooking method. The list below is a general guide to help you select the correct cookware and materials.

MATERIAL	COOKWARE	MICROWAVE COOKING	COMBINATION COOKING	CONVECTION COOKING
Ceramic & Glass	Ceramic	YES	YES	YES
	Ovenproof, Heat-Tempered, Microwave-Safe Glassware	YES	YES	YES
	Glassware with Metal Decoration	NO	NO	YES
	Lead Glass	NO	NO	YES
China	Without Metal Decoration (Ovenproof and Heat-Tempered)	YES	YES	YES
Pottery	Ovenproof Pottery	YES	YES	YES
Plastic	Ovenproof	YES	YES	YES
	Microwave-Safe Plasticware	YES	NO	NO
Metal	Bake/Roast Rack	NO	NO	YES
	Metal Baking Pan	NO	NO	YES
Aluminum Foil		*	*	YES
Paper	Cups, Plates, Towels	YES	NO	NO
Straw, Wicker, Wood		YES	NO	NO
Wax Paper		YES	NO	NO
Plastic Wrap		YES	NO	NO

YES: Cookware to use
 NO: Cookware to avoid

* Refer to "Microwave cooking tips" and "Questions and Answers" for proper use.

Questions and Answers

QUESTIONS	ANSWERS
Can I use a rack in my microwave oven so that I may reheat or cook on two levels at a time?	You can use a rack only if the rack is supplied with your microwave oven. Use of any rack not supplied with the microwave oven can result in poor cooking performance and/or arcing.
Can I use either metal or aluminum pans in my microwave oven?	Useable metal includes aluminum foil for shielding (use small, flat pieces), small skewers, and shallow foil trays (if tray is not taller than 3/4-inch deep and half filled with food to absorb microwave energy). Never allow metal to touch walls or door. (For more information, see the "Microwave cooking tips" section.)
Sometimes the door of my microwave oven appears wavy. Is this normal?	This appearance is normal and does not affect the operation of your oven.
What are the humming noises that I hear when my microwave oven is operating?	You hear the sound of the transformer when the magnetron tube cycles on.
Why does the dish become hot when I microwave food in it? I thought that this should not happen.	As the food becomes hot it will conduct the heat to the dish. Be prepared to use hot pads to remove food after cooking.
What does "standing time" mean?	"Standing time" means that food should be removed from the oven and covered for additional time to allow it to finish cooking. This frees the oven for other cooking.
Can I pop popcorn in my microwave oven? How do I get the best results?	Yes. Pop packaged microwave popcorn following manufacturer's guidelines or use the preprogrammed POPCORN pad. Do not use regular paper bags. Use the "listening test" by stopping the oven as soon as the popping slows to a "pop" every 1 or 2 seconds. Do not repop unpopped kernels. You can also use special microwave poppers. When using a popper, be sure to follow manufacturer's directions. Do not pop popcorn in glass cookware.
Why does steam come out of the air exhaust vent?	Steam is normally produced during cooking. The microwave oven has been designed to vent this steam out the top vent.

If You Need Assistance or Service

This section is designed to help you save the cost of a service call. Part 1 of this section outlines possible problems, their causes, and actions you can take to solve each problem. Parts 2 and 3 tell you what to do if you still need assistance or service. When calling our Consumer Assistance Center for help or calling for service, please provide a detailed description of the problem, your appliance's complete model and serial numbers, and the purchase date. (See the "A Note to You" section.) This information will help us respond properly to your request.

1. Before calling for assistance ...

Performance problems often result from little things you can find and fix without tools of any kind. Please check the chart below for problems you can fix. It could save you the cost of a service call.

PROBLEM	POSSIBLE CAUSE	SOLUTION
Nothing will operate	<p>The unit is not wired into a live circuit with the proper voltage.</p> <p>A household fuse has blown or a circuit breaker has tripped.</p> <p>The electric company has experienced a power failure.</p>	<p>Contact a qualified Whirlpool service technician to wire unit into a live circuit with the proper voltage. (See Installation Instructions.)</p> <p>Replace household fuse or reset circuit breaker.</p> <p>Check electric company for a power failure.</p>
The microwave oven will not run	<p>You are using the oven as a timer.</p> <p>If you are using the Temperature Probe, probe is not plugged tightly into its socket.</p> <p>The door is not firmly closed and latched.</p> <p>You did not touch START/ENTER.</p> <p>You did not follow directions exactly.</p> <p>An operation that was programmed earlier is still running.</p>	<p>Touch TIMER OFF to cancel the Minute Timer.</p> <p>Plug Temperature Probe tightly into its socket.</p> <p>Firmly close and latch door.</p> <p>Touch START/ENTER.</p> <p>Check instructions for the function you are operating.</p> <p>Touch OFF/CANCEL to cancel previous programming.</p>
Microwave cooking times seem too long	<p>The electric supply to your home or wall outlets is low or lower than normal.</p>	<p>Your electric company can tell you if the line voltage is low. Your electrician or service technician can tell you if the outlet voltage is low.</p>

IF YOU NEED ASSISTANCE OR SERVICE

PROBLEM	POSSIBLE CAUSE	SOLUTION
Microwave cooking times seem too long (continued)	The Cook Power is not at the recommended setting. Larger amounts of food need longer cooking times.	Check "Microwave cooking chart." Allow for more time when cooking more food at one time.
The Display shows a time counting down but the oven is not cooking	The oven door is not closed completely. You have set the controls as a minute timer.	Completely close oven door. Touch TIMER OFF to cancel the Minute Timer.
You do not hear the Programming Tone	The command is not correct.	Re-enter command.
Foods undercook during convection and combination cooking	You have not followed the recipe closely enough. Foods are not prepared and ready to place in the oven. This increases heat loss from the door being open.	Follow reliable recipes exactly for ingredients, cookware, cooking time, and proper rack position. Make sure foods are properly prepared and ready to place in oven.
Smoke is coming from back of oven during broiling	This is normal, just as in conventional broiling.	
The microwave oven turns off too soon or not soon enough when using the Temperature Probe	Probe is not pushed far enough into the food. Probe is not positioned correctly in the food. When cooking roasts, you have not let roast stand after cooking. Probe is not plugged in correctly. Cook Power is not set correctly. Probe temperature is not set correctly.	Insert at least $\frac{1}{3}$ of probe into the food. Position probe tip in the center of the food. Allow roast to stand for a few minutes after cooking. Plug probe tightly into its socket. Reset the Cook Power. Reset the probe temperature.
The Display shows "888:88"	There has been a power interruption.	Reset the clock.

continued on next page

IF YOU NEED ASSISTANCE OR SERVICE

2. If you need assistance ...

Call the Whirlpool Consumer Assistance Center telephone number. Dial toll-free from anywhere in the U.S.A.:

1-800-253-1301

and talk with one of our trained consultants. The consultant can instruct you in how to obtain satisfactory operation from your appliance or, if service is necessary, recommend a qualified service company in your area.

If you prefer, write to:

Whirlpool Brand Home Appliances
Consumer Assistance Center
c/o Correspondence Dept.
2000 North M-63
Benton Harbor, MI 49022-2692

Please include a daytime phone number in your correspondence.

3. If you need service ...



Whirlpool has a nationwide network of authorized Whirlpool service companies. Whirlpool service technicians are trained to fulfill the product warranty and provide after-warranty service, anywhere in the United States. To locate the authorized Whirlpool service company in your area, call our Consumer Assistance Center telephone number (see Step 2) or look in your telephone directory Yellow Pages under:

**• APPLIANCE-HOUSEHOLD-
MAJOR, SERVICE & REPAIR**

- See: Whirlpool Appliances or
Authorized Whirlpool Service
(Example: XYZ Service Co.)

**• WASHING MACHINES &
DRYERS, SERVICE & REPAIR**

- See: Whirlpool Appliances or
Authorized Whirlpool Service
(Example: XYZ Service Co.)

4. If you are not satisfied with how the problem was solved ...

- Contact the Major Appliance Consumer Action Program (MACAP). MACAP is a group of independent consumer experts that voices consumer views at the highest levels of the major appliance industry.
- Contact MACAP only when the dealer, authorized servicer, and Whirlpool have failed to resolve your problem.

Major Appliance Consumer Action Program
20 North Wacker Drive
Chicago, IL 60606

- MACAP will in turn inform us of your action.

WHIRLPOOL®

Microwave Oven Warranty

LENGTH OF WARRANTY	WHIRLPOOL WILL PAY FOR
FULL ONE-YEAR WARRANTY FROM DATE OF PURCHASE	FSP® replacement parts and repair labor to correct defects in materials or workmanship. Service must be provided by an authorized Whirlpool service company.
LIMITED FOUR-YEAR WARRANTY SECOND THROUGH FIFTH YEAR FROM DATE OF PURCHASE	FSP replacement magnetron tube on microwave ovens if defective in materials or workmanship.
WHIRLPOOL WILL NOT PAY FOR	
<p>A. Service calls to:</p> <ol style="list-style-type: none"> 1. Correct the installation of your microwave oven. 2. Instruct you how to use your microwave oven. 3. Replace house fuses or correct house wiring. 4. Replace owner-accessible light bulbs. <p>B. Repairs when your microwave oven is used in other than normal, single-family household use.</p> <p>C. Pickup and delivery. Your microwave oven is designed to be repaired in the home.</p> <p>D. Damage to your microwave oven caused by accident, misuse, fire, flood, acts of God, or use of products not approved by Whirlpool.</p> <p>E. Any labor costs during limited warranty.</p> <p>F. Repairs to parts or systems caused by unauthorized modifications made to the appliance.</p>	

3/96

WHIRLPOOL CORPORATION SHALL NOT BE LIABLE FOR INCIDENTAL OR CONSEQUENTIAL DAMAGES. Some states do not allow the exclusion or limitation of incidental or consequential damages, so this exclusion or limitation may not apply to you. This warranty gives you specific legal rights, and you may also have other rights which vary from state to state.

Outside the United States, a different warranty may apply. For details, please contact your authorized Whirlpool dealer.

If you need service, first see the "If You Need Assistance or Service" section of this book. After checking "If You Need Assistance or Service," additional help can be found by calling our Consumer Assistance Center telephone number, **1-800-253-1301**, from anywhere in the U.S.A.